

PERTRONIX *IGNITION PRODUCTS*



***Quality Products
for Over 40 Years*** ***2018***



We are excited to present our 2018 catalog featuring many new applications, updates and industry changing new products.

First and foremost we are proud to announce our new Digital HP CD Ignition box jam-packed with features that blow away the competition. Complimenting the new Digital HP we have designed a matching FlameThrower HP coil and greatly expanded our magnetic distributor line giving more options to our Digital HP customers.

Honoring the requests of our customers we have added a line of High Temperature 8MM Ceramic Boot ignition wires available in straight, 90 & 45 degree boot configurations

Venturing into new product categories is nothing new for the team at PerTronix and for the first time you will find our new sleek and unique Contour Starters available in a wide variety of applications.

Visit www.pertronix.com to locate your nearest dealer or to order online.



PERTRONIX IGNITION PRODUCTS



PERTRONIX IGNITION PRODUCTS
www.pertronix.com



TABLE OF CONTENTS

NEW PRODUCTS	2
CONTOUR STARTERS	3
ELECTRONIC IGNITION CONVERSIONS	
IGNITOR / IGNITOR II / IGNITOR III FEATURES	4-5
AUTOMOTIVE IGNITOR ELECTRONIC IGNITION	6-22
ELECTRONIC IGNITION SERVICE PARTS	22
IGNITION ACCESSORIES	23
MARINE IGNITOR ELECTRONIC IGNITION	24-26
INDUSTRIAL IGNITOR ELECTRONIC IGNITION	27-34
AGRICULTURAL IGNITOR ELECTRONIC IGNITION	35-39
PERFORMANCE DISTRIBUTORS	
AUTOMOTIVE BILLET DISTRIBUTORS	40-42
MARINE BILLET DISTRIBUTORS	43
MAGNETIC TRIGGER BILLET DISTRIBUTORS	44
IGNITION SYSTEM BUNDLES	45
BILLET DISTRIBUTOR PARTS & ACCESSORIES	46
“STOCK LOOK” CAST DISTRIBUTORS	47-50
“STOCK LOOK” REPLACEMENT PARTS	51
HEI DISTRIBUTORS	52-53
HEI DISTRIBUTOR PARTS & ACCESSORIES	54-55
INDUSTRIAL DISTRIBUTORS	56-58
IGNITION COILS	
FLAME-THROWER CANISTER COILS	59-60
FLAME-THROWER E-CORE COILS	61-62
FLAME-THROWER LS COILS	63-64
FLAME-THROWER COIL ON PLUG	65
IGNITION BOX AND REV LIMITER	
DIGITAL HP IGNITION BOX	66
SECOND STRIKE	67
DIGITAL REV LIMITER	68
SPARK PLUG WIRE SETS	
FLAME-THROWER MAGX2 8MM WIRES	69-73
FLAME-THROWER MAGX2 “CERAMIC SP” 8MM WIRES	74
FLAME-THROWER “STOCK LOOK” 7MM WIRES	75-79
QUICK CHANGE RATCHET CRIMP TOOLS	80

NEW
Digital HP



DIGITAL HP IGNITION BOX - PAGE 66

The new **Digital HP** from PerTronix represents the latest innovation in Ignition technology. The **Digital HP** is unique featuring an ultra small form factor packing more power than the competition. No other box on the market has the versatility at the price point. Programming the **Digital HP** with its four rotary dials can be done in minutes. Positive wire retention is insured with a high quality locking automotive Molex connector making installation a snap. The secrets are all contained in a proprietary microprocessor controlling every aspect of the **Digital HP**. The **Digital HP** is compatible in even or odd fire 1, 2, 4, 6, 8 or 12-cylinder engines and can be triggered by traditional breaker points, Ignitor or Ignitor II modules or magnetic triggers found in our FlameThrower Mag Trigger Distributors.

SEE PAGE 45 & 66 FOR FEATURES AND BENEFITS



Flame-Thrower®
IGNITION SYSTEM BUNDLES

Going to a complete PerTronix ignition system will improve your performance with more horsepower and better throttle response. PerTronix Ignition makes it easy by including everything you need in one box at a great price. These bundles include a Flame-Thrower Billet Plug n' Play distributor with Ignitor II or Ignitor III module technology, a matching low resistance Flame-Thrower chrome coil topped off with a set of Flame-Thrower 8mm MAGx2 universal wires featuring silicone jackets to resist high temperatures. Bundles are available for the most popular Chevrolet and Ford engines as well as Chevrolet Marine

SEE PAGE 45 FOR FEATURES AND BENEFITS

8MM UNIVERSAL MAGX2 CERAMIC BOOT SPARK PLUG WIRES

PerTronix MAGX2 Ceramic boot wires are the answer to your burnt wire blues. Each wire is constructed from two layers of ultra-high temperature silicone and rated up to 600°F. The Ceramic spark plug boot acts as the primary protection to direct heat withstanding up to 2,000°F. Available in universal sets with straight, 45 or 90-degree boot angle configurations. Kits include distributor boots and terminal for both male and female style distributor caps.

Ceramic boots also available separately.



90°



Straight



45°



SEE PAGE 74 FOR FEATURES AND BENEFITS

COMBINING FORM & FUNCTION

CONTOUR STARTERS



S3003P



S3000P



S3005P

NEW

MARINE APPROVED
SAE J1171 Certified

FEATURES

- Contour starters offer a sleek design which combines form and function
- Fully enclosed aluminum body protects the components from the elements and damaging heat
- Adjustable starter clocking for improved clearance around headers and other parts
- Powerful Nippondenso motor combined with a 4.4:1 gear ratio produces 200 lb/ft of torque for dependable starting of high compression engines
- Available in show quality polished or black powdercoat finish
- Marine Approved SAE J1171 Certified versions also available

Description	AUTOMOTIVE		MARINE ENGINES	
	Black Part No.	Polished Part No.	Black Part No.	Polished Part No.
BUICK Contour Starter Pontiac/Olds 1965-81 V8 engines excluding 301	S3006B	S3006P	S3006B-M	S3006P-M
CHEVROLET Contour Starter 1964-2000 Chevrolet SB/BB, 153T and 168T flywheels	S3000B	S3000P	S3000B-M	S3000P-M
Contour Starter 1963-74 L6 (230, 250, 292) with straight bolt pattern	S3000B	S3000P	S3000B-M	S3000P-M
FORD Contour Starter 1963-1987 221-302/5.0L, 351W and 351C with 3 or 4 speed manual trans (164T flywheel), 3/8" offset	S3003B	S3003P	S3003B-M	S3003P-M
Contour Starter Ford 1963-2001 221-302/5.0L, 351W and 351C with automatic and 5 speed manual trans (157T or 164T flywheel), 3/4" offset	S3004B	S3004P	S3004B-M	S3004P-M
GM Contour Starter GM LS engines	S3002B	S3002P	S3002B-M	S3002P-M
MOPAR Contour Starter Mopar 1963-2003 SB-LA/BB-B & RB, 426 Hemi, 1962-87 L6, 1962-66 318 Poly (with nose cone)	S3005B	S3005P	S3005B-M	S3005P-M
OLDSMOBILE Contour Starter Pontiac/Olds 1965-81 V8 engines excluding 301	S3006B	S3006P	S3006B-M	S3006P-M
PONTIAC Contour Starter Pontiac/Olds 1965-81 V8 engines excluding 301	S3006B	S3006P	S3006B-M	S3006P-M

IGNITOR® ELECTRONIC IGNITION

For over forty years, the Ignitor has proven itself in applications ranging from race cars to tractors. The Ignitor replaces breaker points and troublesome factory electronic ignitions with a dependable, self contained and maintenance free electronic ignition system. The Ignitor has been called the "stealth" ignition because of its quick installation and nearly undetectable presence under your distributor cap. There is no "black-box" to clutter the engine compartment. For optimal performance, use the Ignitor with Flame-Thrower 40,000 volt coils.

FEATURES

- Delivers twice the voltage to the spark plugs, increasing horsepower, fuel economy, and spark plug life
- 2:1 improvement over "points" in current fall time for increased coil output
- Rotating cobalt magnets* trigger a Hall Effect integrated circuit. ...no points to burn, ...no moving parts to wear out
- Epoxy molding makes our module impervious to dirt, oil, grease and moisture
- Stable timing ...no need for adjustment
- Will trigger most CD ignitions
- Available for 6 and 12-volt negative and positive ground systems
- Legal in all 50 states and Canada. (C.A.R.B. E.O. #D-57-22)
- Guaranteed for 30 months... We Stand Behind It!

* Some kits feature lobe sensing technology which does not utilize rotating magnets

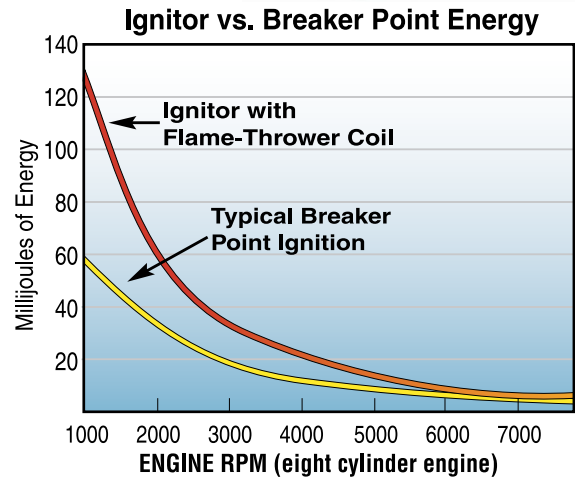

Ignitor II® ELECTRONIC IGNITION

The Ignitor II has many of the same great features that the Ignitor has, but even more. The Ignitor II units sense the coil current level and use a powerful micro controller to adjust the dwell. Variable dwell helps to maintain peak energy throughout the entire RPM range. Ignitor II systems develop significantly more energy between 3000 and 5000 RPM than standard ignition systems. High RPM performance is improved when used with the Flame-Thrower II super low resistance (0.6 ohms) 45,000 volt coils.

FEATURES

- Adaptive dwell maintains peak energy throughout the entire RPM range, reducing misfires while improving engine performance
- Develops on average 4 times more available energy between 3000 and 5000 RPM, and 2 times more available plug voltage
- Compensates for inherent electronic delay by adjusting the spark timing throughout the entire RPM range
- Synchronized peak current and spark timing reduces heat build-up
- Senses startup and develops more energy for quicker, easier starting
- Built in reverse polarity and over current protection shuts down the system, preventing component damage
- Epoxy molding makes our module impervious to dirt, oil, grease and moisture
- Stable timing ...no need for adjustment
- Will trigger most CD ignitions
- Legal in all 50 states and Canada. (C.A.R.B. E.O. #D-57-22)
- Guaranteed for 30 months... We Stand Behind It!

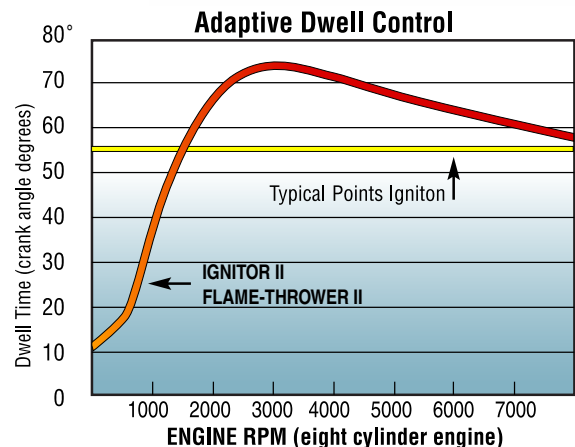

Ignitor[®] III **ELECTRONIC IGNITION**

Our Ignitor III ignition module is designed for the serious performance enthusiast who demands serious power. You have seen the performance increases the Ignitor and Ignitor II series of electronic ignitions have brought. Now get ready for more... 5 times more spark energy than a typical points system. Ignitor III modules provide ignition box performance... without the "box"! For the maximum Ignitor III benefit, select one of our Flame-Thrower III or HC ignition coils from the coil section of this catalog.



FEATURES

- Multiple sparks thru the entire RPM range
- Integrated digital REV limiter with LED feedback for precise RPM setting
- Memory safe function stores settings eliminating unintended changes to Rev limit
- Adaptive dwell maintains peak energy throughout the entire RPM range, reducing misfires while improving engine performance
- Peak current level is reached just prior to spark for maximum energy without the heat build-up, increasing coil performance and module reliability
- Adjusts spark timing at higher RPMs to compensate for inherent electronic delay
- Senses startup and increases energy for quicker, easier starting
- Thermal clad surface mount construction for superior reliability
- Built-in reverse polarity and over current protection shuts down the system, preventing component damage
- Not compatible with CD or Multi-Spark boxes
- Legal in all 50 states and Canada. (C.A.R.B. E.O. #D-57-22)
- Guaranteed for 30 months... We Stand Behind It!

Ignitor III vs. Breaker Point Energy

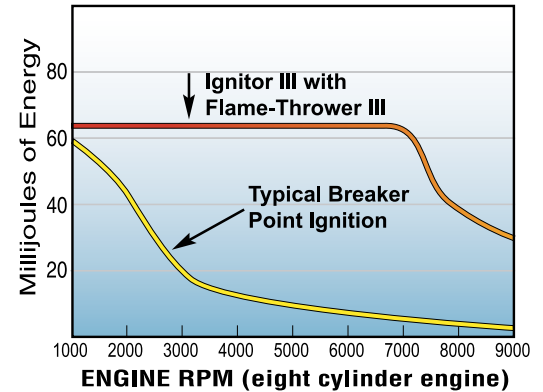

FEATURE COMPARISON

	Ignitor	Ignitor II	Ignitor III
Fits entirely inside the distributor. No "Black Box" to clutter the engine compartment	✓	✓	✓
Stable timing... No need for adjustment	✓	✓	✓
Epoxy molded module makes module impervious to dirt, oil, grease and moisture	✓	✓	
Hall Effect integrated circuit.. No points to burn no moving parts to break	✓	✓	✓
Surface Mount Technology	✓	✓	✓
Legal in all 50 states and Canada (C.A.R.B. E.O. #D-57-22)	✓	✓	✓
Compatible with most point type ignition coils	✓	✓	
Adaptive dwell control maintains peak energy throughout the entire RPM		✓	✓
High RPM timing correction		✓	✓
Engine Start-up energy boost		✓	✓
Reverse polarity and over current protection		✓	✓
Compatible with low resistance ignition coils		✓	✓
Thermal Clad construction			✓
Integrated adjustable REV Limiter with LED feedback			✓
Multi-spark ignition system eliminates the need for CD boxes			✓

APPLICATION NOTES

The following pages represent the most common vehicle makes and models. To assist in selecting the correct part number, use the following general guidelines:

- Read all footnotes before ordering
- Applications are based on the vehicle's original equipment. For kits listed by distributor make and part number, turn to page 16
- Some kits use lobe sensor technology, which uses the point cam or reluctor to trigger and does not use a magnet sleeve or ring
- Applications may have Ignitor, Ignitor II and or Ignitor III kits available. The part numbers for each version are found in their respective columns. Refer to page 2 & 3 for a more detailed description and features of each version
- Unless otherwise noted, the part numbers in this catalog represent 12-volt negative ground kits. Many of our standard Ignitor applications are also available in 6-volt negative ground, as well as 6 and 12-volt positive ground. To order these special variations simply add a N6, P6 or P12 to the end of the part number when ordering. Ignitor II and Ignitor III kits are only available in 12-volt negative ground
- Compatible coils can be found in the coil section of this catalog
- As with all modern electronics, our modules must not be used with solid core spark plug wires. Suppression core spark plug wires can be found in the spark plug wire section of this catalog
- If your application can not be found in this catalog please visit www.pertronix.com or call us at (909) 547-9058 for updated application information
- New applications are listed in red

Year	Cyl	Model	Distributor Notes	Footnotes	Ignitor	Ignitor II	Ignitor III
AC							
1939-48	4	All models	Lucas DKY4A, DKYH4A	13, 56, 57, 79, 86	LU-146LS	9LU-146LS	
ALFA-ROMEO							
1956-62	4	Giulietta Veloce	Marelli S73A	34, 79	MR-143	9MR-143	
1969-70	4	All	Bosch 231100045	34, 79	2848	92848	
1965-78	4	Giulia	Marelli	13, 79	MR-LS1	9MR-LS1	
1966-68	4	Giulia, Spider	Bosch 231100041	34, 55, 79	1844	91844	
1967-68	4	Sprint GT, Veloce	Bosch	34, 55, 79	1844	91844	
1969-70	4	All	Marelli S103B	13, 79	MR-LS2	9MR-LS2	
1969-72	4	Berlina	Marelli	13, 79	MR-LS1	9MR-LS1	
1969-73	4	GT Veloce	Marelli S166B	13, 79	MR-LS1	9MR-LS1	
1969-79	4	Spider Veloce	Marelli S145C, CX, S166B	13, 79	MR-LS1	9MR-LS1	
1971-75	4	Alfetta, Berlina, Spider Veloce	Bosch	33, 79	1847V	91847V	71847V
1972-79	4	Alfetta	Marelli S145C, CX, S166B	13, 79	MR-LS1	9MR-LS1	
1974	4	Spider	Marelli S145C, CX, S166B	13, 79	MR-LS1	9MR-LS1	
1975-78	4	Alfasud, TI, 5M, Sprint	Bosch	33, 79	1847V	91847V	71847V
1976-78	4	Romeo F12 (Versolone Benzina)	Bosch	33, 79	1847V	91847V	71847V
1977-81	4	Alfetta 1.6, 1.8, 2.0 Litre	Bosch	33, 79	1847V	91847V	71847V
1977-81	4	GTV 2000	Bosch	33, 79	1847V	91847V	71847V
1970-77	8	Montreal	Marelli S127C	63, 79, 85, 103	MR-185	9MR-185	
AMC							
1977-79	4	Concord, Gremiln, Spirit	Bosch	33, 79	1847V	91847V	71847V
1955-62	6	All models	Delco	13, 79	1168LS	91168LS	
1960-62	6	All models	AutoLite IAT Series	55, 56, 79, 84, 86	1569	91569	
1963-74	6	All models	Delco	79	1162A	91162A	
1958-70	8	Rebel	Delco	19, 72, 79	1181	91181	71181
1958-74	8	Ambassador	Delco	19, 72, 79	1181	91181	71181
1961-66	8	Classic	Delco	19, 72, 79	1181	91181	71181
1965-67	8	Marlin	Delco	19, 72, 79	1181	91181	71181
1968-74	8	AMX, Javelin	Delco	19, 72, 79	1181	91181	71181
1970-74	8	Hornet, Matador	Delco	19, 72, 79	1181	91181	71181
AMERICAN AUSTIN / BANTAM							
1930-40	4	All models	AutoLite IGB Series	55, 56, 57, 79	1549	91549	
ASTON MARTIN							
1951-58	6	DB2, DB3	Lucas DVXH6A	13, 24, 57, 79	LU-169LS	9LU-169LS	
1958-59	6	DB MKIII Saloon	Lucas DVXH6A	13, 24, 57, 79	LU-169LS	9LU-169LS	
1960-64	6	DB4, DB5	Lucas DMBZ6A	57, 79	LU-165	9LU-165	
1965-77	6	All models	Lucas 25D6	57, 79	LU-162A	9LU-162A	
1969-73	8	DBS	Lucas 35D8	79	LU-181A	9LU-181A	
1973-79	8	All models	Lucas 35DE8	2, 79, 93	LU-281	9LU-281	
AUBURN							
1925-36	6	All models	Delco	13, 55, 56, 57, 79	1168LS	91168LS	
NEW 1927-28	6		Delco 637P 637N	55, 56	2162	92162	
1931-33	8	All models	Delco 660Z	55, 56, 57, 79	2182	92182	
1935-36	8	All models	AutoLite IGP-4002	55, 56, 57, 79	1585A	91585A	

Year	Cyl	Model	Distributor Notes	Footnotes	Ignitor	Ignitor II	Ignitor III
AUDI							
1970-72	4	90, 100LS	Bosch 231167011, 045	33, 79	1847V	91847V	71847V
1972	4	Super 90	Bosch 231176014	33, 79	1847V	91847V	71847V
1973-74	4	Fox, 80LS	Bosch	33, 79	1847V	91847V	71847V
1970-75	4	100, GL, LS	Bosch	33, 79	1847V	91847V	71847V
1976-77	4	100, 100LS (1900cc)	Bosch	33, 79	1847V	91847V	71847V
1975-79	4	Fox 1600cc	Bosch 231176057	33, 79	1847V	91847V	71847V
1979-80	4	4000	Bosch 231176057	1, 33, 79	1847V	91847V	71847V
AUSTIN							
1939-53	4	All models	Lucas DKY4A, DKYH4A	13, 56, 57, 79, 86	LU-146LS	9LU-146LS	
1952-56	4	All models	Lucas DM2P4	13, 56, 57, 70, 79	LU-241LS	9LU-241LS	
1957-62	4	All models	Lucas DM2P4	57, 71, 79	LU-149	9LU-149	
1963-74	4	All models	Lucas 25D4	33, 57, 10, 72, 79, 102	LU-142A	9LU-142A	7LU-142A
1975-79	4	All models	Lucas 45DE4	2, 79	LU-147A	9LU-147A	
1980-on	4	Allegro, Metro	Lucas 59D4	79	LU-143A	9LU-143A	7LU-143A
1949-54	6	Sheerline	Lucas DVX6A	13, 57, 79	LU-168LS	9LU-168LS	
1968-71	6	All models	Lucas 25D6	57, 79	LU-162A	9LU-162A	
AUSTIN-HEALEY							
1953	4	All models	Lucas DKY4A	13, 56, 57, 79, 86	LU-146LS	9LU-146LS	
1954-56	4	100 early distributor	Lucas DM2P4	13, 57, 70, 79	LU-241LS	9LU-241LS	
1954-56	4	100 late distributor	Lucas DM2P4	57, 71, 79	LU-149	9LU-149	
1958-61	4	Sprite	Lucas DM2P4	57, 71, 79	LU-149	9LU-149	
1958-71	4	Sprite	Lucas 25D4	33, 57, 79, 102	LU-142A	9LU-142A	7LU-142A
1958-71	4	Sprite	Lucas 23D4	34, 57, 79	LU-148	9LU-148	
1957-63	6	All models	Lucas DM6	57, 79	LU-165	9LU-165	
1963-68	6	All models	Lucas 25D6	57, 79	LU-162A	9LU-162A	
ASTON MARTIN							
NEW	1972-74	8 DBS	Lucas 41383, 41608	2, 79	LU-188		
AUSTIN SEVEN							
1934-39	4	All models	Lucas DK4A, DKY4A	13, 56, 57, 79, 86	LU-146LS	9LU-146LS	
BENTLEY							
1962-68	8	T Series, Continental	Lucas 20D8	57, 79	RR-181	9RR-181	
1966-74	8	T Series, Continental	Lucas 35D8	79	LU-181A	9LU-181A	
BMW							
1968	4	1600	Bosch 0231115048	79	1847V	91847V	71847V
1969-70	4	2000	Bosch	3, 33, 79	1847V	91847V	71847V
1969-72	4	2002	Bosch	3, 33, 79	1847V	91847V	71847V
1972-73	4	2002 Tii	Bosch	33, 79	1847V	91847V	71847V
1972-73	4	2002	Bosch 231180008	79	1843	91843	
1972-73	4	2002	Bosch 231180003	33, 79	1847V	91847V	71847V
1974	4	2002 Tii, 2002	Bosch	79	1843	91843	
1975-76	4	2002	Bosch	33, 79	1847V	91847V	71847V
1977-79	4	320i	Bosch	33, 79	1847V	91847V	71847V
1974	6	3.0 CSi	Bosch	79	1868	91868	
1975	6	530i	Bosch	79	1868	91868	
1975-76	6	3.0 Si, CSi	Bosch	1, 79	1868	91868	
1976-78	6	530i	Bosch	1, 79	1868	91868	
1977-78	6	630 CSi	Bosch	1, 79	1868	91868	
BRISTOL							
1949-61	6	All models	Lucas DX6A	13, 22, 57, 79	LU-169LS	9LU-169LS	
BUICK							
1929-30	6	All models	Delco	13, 55, 56, 57, 62, 79	1168LS	91168LS	
1962-67	6	All V-6 models	Delco	19, 43, 79	1165		
1968-74	6	All models	Delco	16, 79	1162A	91162A	
1931-33	8	All models	Delco 660E, 662B	10, 16, 55, 56, 57, 63, 79	2182	92182	
1935-37	8	All models	Delco 663	16, 55, 56, 65, 79	1183	91183	
1938-56	8	All models	Delco	16, 55, 65, 79	1183	91183	
1938-56	8	All models	Delco	13, 16, 65, 79	1185LS		
1957-74	8	All models	Delco	19, 72, 79	1181	91181	71181
1957-74	8	All models	Delco	13, 18, 19, 79	1181LS	91181LS	71181

FOOTNOTES

1 Excluding California models	34 Non vacuum advance distributor	79 Not for use with solid core spark plug wires
2 Factory electronic ignition	43 Odd fire engine	84 Ignitor version available in 24v negative ground add N24 suffix
3 Excluding Bosch distributor number 0231115045	55 Ignitor version available in 6V negative ground, add N6 suffix	85 Point cam felt bracket removal required
10 Dual point distributor	56 Ignitor version available in 6V positive ground, add P6 suffix	86 Requires modification to distributor
13 Lobe sensor module	57 Ignitor version available in 12V positive ground, add P12 suffix	93 Excluding distributor number 41383, 41608
16 Mechanical advance under breaker plate	62 With six lobe point cam	102 Complete "Stock-Look" distributors available on page 47-50
18 Excluding 215 and 300 cid. engine	63 With four lobe point cam	103 Kit contains two modules for dual coil application
19 Mechanical advance at top of shaft	65 With eight lobe point cam	
22 Clockwise rotation	70 Early DM2 distributor with two piece point set	
24 Counter clockwise rotation	71 Late DM2 distributor with one piece point set	
33 Vacuum advance distributor	72 Fit both single point and dual point distributors	

Year	Cyl	Model	Distributor Notes	Footnotes	Ignitor	Ignitor II	Ignitor III
CADILLAC							
1932-33	8	All models	Delco 660, 662	10, 63, 55, 56, 57, 79	2181	92181	
1938-55	8	All models	Delco	16, 55, 56, 65, 79	1183	91183	
1956-74	8	All models	Delco	13, 18, 19, 79	1181LS	91181LS	71181
1956-74	8	All models	Delco	19, 72, 79	1181	91181	71181
CHANDLER							
NEW 1927-29	6	All models	Delco 633B, C, D, E 637V, X, U	55, 56, 79	2162	92162	
CHECKER CAB							
1964-74	6	230-250 cid. engine	Delco	16, 79	1162A	91162A	
1935-39	8	Y	AutoLite IGT-4003	56, 79	1587	91587	
1964-74	8	All models	Delco	19, 79	1181	91181	71181
CHEVROLET							
NEW 1927-29	4	All models	Delco 635B, 635J	55, 56, 79	2142	92142	
NEW 1930-35	6	Truck	Delco 622S, 622Y, 639U	55, 56, 79	2162	92162	
1962-74	4	All models	Delco	79	1144A	91144A	
1974-75	4	LUV Pickup	Hitachi	79	1741	91741	
1976-80	4	LUV Pickup	Nippondenso	79	1643	91643	
NEW 1929-34	6	All models	Delco 622L, 633J, 633G, 633U	55, 56, 79	2162	92162	
1933-62	6	All models	Delco	13, 36, 40, 55, 56, 57, 79	1168LS	91168LS	
1953	6	Corvette	Delco 1112314	55, 79	1161	91161	
1963-74	6	All models	Delco	16, 79	1162A	91162A	
1937-61	8	All models	Delco	16, 55, 79	1183	91183	
1957-74	8	All models	Delco	19, 72, 79, 102	1181	91181	71181
1957-74	8	All models	Delco	13, 19, 79, 102	1181LS	91181LS	71181
COMMER							
1939-53	4	All models	Lucas DKYH4A	13, 56, 57, 79, 86	LU-146LS	9LU-146LS	
CORD							
1929-32	8		Delco 658W	10, 56, 57, 63, 79	2183	92183	
1936-37	8		AutoLite IGP-4006	56, 79	1585A	91585A	
CHRYSLER							
NEW 1926-28	4		Delco 629K	55, 56, 79	2142	92142	
1984-88	4	Colt non turbo	Mitsubishi	2, 79	1944	91944	
1985-89	4	2600cc Pickup	Mitsubishi	2, 79	1944	91944	
1987-89	4	Raider	Mitsubishi	2, 79	1944	91944	
NEW 1928-33	6	All models	Delco 622C, 632D, 632L, 632K, 639X, 631B	55, 56, 79	2162	92162	
1933-34	6	All models	Delco	13, 36, 40, 55, 56, 57, 79	1168LS	91168LS	
1935-42	6	All models	AutoLite IGS, IAP Series	13, 55, 56, 57, 79	2563LS	92563LS	
1946-50	6	All models	AutoLite IGS, IAP Series	13, 55, 56, 57, 79	2563LS	92563LS	
1978-83	6	All models	Chrysler	2, 15, 79	CH-161	9CH-161	
1931-32	8	All models	Delco 660	10, 63, 56, 79	2181	92181	
1932-35	8	All models	Delco 661	16, 55, 79	1183	91183	
1935-42	8	All models	AutoLite IGT-4001	56, 79	1587	91587	
1946-48	8	All models	AutoLite IGT-4002	56, 79	1587	91587	
1949-50	8	All models	AutoLite IAR-4101	56, 79	1587	91587	
1951-58	8	331cid engine	AutoLite IBK, IAZ Series	10, 56, 79	1385	91385	71385
1957-62	8	All models	AutoLite IBP Series	8, 79	1385	91385	71385
1959-71	8	383-440cid. engine (including Hemi)	Auto/Prestolite	10, 79	1385	91385	71385
1968-73	8	340 six pack	Prestolite	79	1384	91384	
1962-75	8	All models	Chrysler	8, 79, 102	1381A	91381A	71381A
1972-83	8	All models	Chrysler	2, 15, 79	CH-181	9CH-181	
CITROËN							
1940-52	4	All models	Lucas DKH4A, DKYH4A	13, 56, 57, 79, 86	LU-146LS	9LU-146LS	
1952-55	4	All models	Lucas DM2P4	57, 71, 79	LU-149	9LU-149	
1957-65	4	ID, DS	SEV A147	55, 35, 79	SV-142	9SV-142	
1965-66	4	ID19 80cv	Ducellier 4944, 4175	55, 79	EP-141		
1965-67	4	DS19 90cv	Ducellier 4169, 4177A	55, 79	EP-141		
1966-70	4	ID16 90cv	Ducellier 41401, 4188	55, 79	EP-141		
1965-72	4	DS21 109cv, Pallas 105cv	Ducellier 4155, 4176	55, 79	EP-141		
1968-72	4	DS21	SEV A253	55, 79	SV-141	9SV-141	
1933-57	4	Traction Avant 11	Ducellier	55, 79	EP-141		
NEW 1973	4	GS	Ducellier 4451A	79, 86	EP-142		
1938	6	15/6	SEV	55, 79	SV-161	9SV-161	
CROSLEY							
1946-52	4	All models	AutoLite IGW-4181	56, 79, 110	1545	91545	
DAIMLER							
1969-71	6	All 4.2 models	Lucas 22D6	57, 79	LU-166A	9LU-166A	
1960-64	8	SP250	Lucas 20D8	57, 79	RR-181	9RR-181	

Year	Cyl	Model	Distributor Notes	Footnotes	Ignitor	Ignitor II	Ignitor III
DESOTO							
NEW 1928-33	6	All models	Delco 622C, 632L	55, 56, 79	2162	92162	
1933-34	6	All models	Delco	13, 36, 40, 55, 56, 57, 79	1168LS	91168LS	
1935-42	6	All models	Autolite IGS, IAP Series	13, 55, 56, 57, 79	2563LS	92563LS	
1946-50	6	All models	Autolite IGS, IAP Series	13, 55, 56, 57, 79	2563LS	92563LS	
1950	6	All models	Autolite IAT-4004	79, 86	1362	91362	
1930-31	8	All models	Delco 660	10, 63, 55, 56, 57, 79	2181	92181	
1952-55	8	All models	Autolite IBK, IAZ Series	10, 56, 79	1385	91385	71385
1957-61	8	All models	Autolite IBP Series	8, 79	1385	91385	71385
DODGE							
NEW 1930-32	4	Truck	Delco 629A, 629E	55, 56, 79	2142	92142	
1980	4	Colt, Challenger w/1400,1600 engine	Hitachi	1, 79	1741	91741	
1981	4	Colt	Hitachi	5, 79	1741	91741	
1985-89	4	2.6L Raider, Ram Pickup	Mitsubishi	2, 79	1944	91944	
NEW 1930-33	6	All models	Delco 622H, 632K, 632L	55, 56, 79	2162	92162	
1933-34	6	All models	Delco	13, 36, 40, 55, 56, 57, 79	1168LS	91168LS	
1935-42	6	All models	Autolite IGS, IAP Series	13, 55, 56, 57, 79	2563LS	92563LS	
1946-50	6	All models	Autolite IGS, IAP Series	13, 55, 56, 57, 79	2563LS	92563LS	
1960-72	6	All models	Chrysler	79	1361A	91361A	
1973-83	6	All models	Chrysler	2, 15, 79	CH-161	9CH-161	
1930-31	8	All models	Delco 660	10, 63, 56, 79	2181	92181	
1932-33	8	All models	Delco 661	16, 55, 79	1183	91183	
1953-55	8	All models	Autolite IBK, IAZ Series	10, 56, 79	1385	91385	71385
1957-58	8	All models	Autolite IBK, IAZ Series	10, 56, 79	1385	91385	71385
1957-61	8	All models	Autolite IBP Series	8, 79	1385	91385	71385
1959-71	8	383-440 cid. engine (including Hemi)	Auto/Prestolite	10, 79	1385	91385	71385
1968-73	8	340 six pack engine	Prestolite	79	1384	91384	
1960-72	8	All models	Chrysler	8, 79, 102	1381A	91381A	71381A
1972-83	8	All models	Chrysler	2, 79, 15	CH-181	9CH-181	
DODGE BROTHERS							
1919-26	4	All models	N.E. Electric 10004	56, 57, 79	NE-141	9NE-141	
1927-30	6	All models	N.E. Electric 10836, 10846	56, 57, 79	NE-161	9NE-161	
ELCAR							
NEW 1929-31	6	All models	Delco 631D, 631E, 632H, 639S	55, 56, 79	2162	92162	
FEDERAL							
NEW 1936-38	4	Truck	Delco 625H, 625M, 625J	55, 56, 79	2142	92142	
NEW 1933-39	6	Truck	Delco 622D, 623P, 623R, 639K, 639S	55, 56, 79	2162	92162	
FERRARI							
1966-74	6	Dino 246GT, GTS	Marelli S125	64, 79, 85	MR-161A	9MR-161A	
1967-69	6	Dino 206	Marelli S125	64, 79, 85	MR-161A	9MR-161A	
1975	8	Dino 208 GT4	Marelli S127	14, 59, 63, 79, 85	MR-181A	9MR-181A	
1975-78	8	308	Marelli S159A, S159AD, S159B	60, 61, 63, 79, 85	MR-182A	9MR-182A	
1975-78	8	308	Marelli S159A, S159AD, S159B	63, 79, 85, 94, 60	MR-183	9MR-183	
1977	8	308 GTB	Marelli S127	14, 59, 63, 79, 85	MR-181A	9MR-181A	
1966-68	12	330 GTC, 365	Marelli S85A, S125	60, 61, 64, 79, 85	MR-1122A	9MR-1122A	
1970-72	12	365 GT	Marelli S85A, S138	60, 61, 62, 79, 85	MR-1121A	9MR-1121A	
1970-72	12	330, 365	Marelli S129E	14, 59, 64, 79, 85	MR-1124	9MR-1124	

FOOTNOTES

<p>1 Excluding California models</p> <p>2 Factory electronic ignition</p> <p>5 Canadian models only</p> <p>8 Single point distributor</p> <p>10 Dual point distributor</p> <p>13 Lobe sensor module</p> <p>14 European models only</p> <p>15 Excluding lean burn computer controlled engines</p> <p>16 Mechanical advance under breaker plate</p> <p>18 Excluding 215 and 300 cid. engine</p> <p>19 Mechanical advance at top of shaft</p> <p>35 Special keeper no. MR-122K required for distributors without distributor cap</p> <p>36 Excluding distributor number 1112314</p>	<p>40 With "straight" point set</p> <p>55 Ignitor version available in 6V negative ground, add N6 suffix</p> <p>56 Ignitor version available in 6V positive ground, add P6 suffix</p> <p>57 Ignitor version available in 12V positive ground, add P12 suffix</p> <p>59 Single distributor applications</p> <p>60 Dual distributor applications</p> <p>61 Kit contains one module for each distributor</p> <p>62 With six lobe point cam</p> <p>63 With four lobe point cam</p> <p>64 With three lobe point cam</p> <p>65 With eight lobe point cam</p> <p>71 Late DM2 distributor with one piece point set</p> <p>72 Fit both single point and dual point distributors</p> <p>79 Not for use with solid core spark plug wires</p>	<p>85 Point cam felt bracket removal required</p> <p>86 Requires modification to distributor</p> <p>94 Enables one distributor to control timing and advance for both cylinder banks.</p> <p>102 Complete "Stock-Look" distributors available on page 47-50</p> <p>110 Excluding distributor number IGW-4181C</p>
----------------------------------------------------------------------------------------------------------------------------------------------------------------------------------------------------------------------------------------------------------------------------------------------------------------------------------------------------------------------------------------------------------------------------------------------------------------------------------------------------------------------------------------------------------------------------------	-----------------------------------------------------------------------------------------------------------------------------------------------------------------------------------------------------------------------------------------------------------------------------------------------------------------------------------------------------------------------------------------------------------------------------------------------------------------------------------------------------------------------------------------------------------------------------------------------------------------------------------------------------------------------------------------------------------------------------------	-------------------------------------------------------------------------------------------------------------------------------------------------------------------------------------------------------------------------------------------------------------------------------------------------------------------

Year	Cyl	Model	Distributor Notes	Footnotes	Ignitor	Ignitor B	Ignitor D2
FIAT							
1955-75	2	500	Marelli S76	35, 79	MR-122		
1972-88	2	126	Marelli S152	35, 79	MR-122		
1939-55	4	Topolino	Marelli S50	13, 79	MR-148LS	9MR-148LS	
All	4	600, 750, 770, Multipla, Seat	Marelli S77A, S83C	79	MR-147	9MR-147	
1960-65	4	150D Cabrioler 118H, K, Ghia Coupe	Marelli S91	13, 79	MR-LS2	9MR-LS2	
1964-69	4	118Sb	Marelli S106	13, 79	MR-LS2	9MR-LS2	
1964-74	4	850	Ducellier 4290A	13, 79	DU-142LS	9DU-142LS	
1965-69	4	850	Marelli S118	13, 79	MR-LS3	9MR-LS3	
1967-77	4	1300 Berlina, 1500 Berlina	Marelli S91, S108	13, 79	MR-LS2	9MR-LS2	
1967-77	4	1500L, 1600S Cabrioler, Familia	Marelli S91, S106, S108	13, 79	MR-LS2	9MR-LS2	
1969	4	124 Coupe	Marelli S124B	13, 79	MR-LS3	9MR-LS3	
1969-74	4	128, 850 Spyder	Marelli S135, S140	79	MR-145	9MR-145	
1969-77	4	125 Berlina,	Marelli S147	13, 79	MR-LS1	9MR-LS1	
1970-77	4	Berlina	Marelli S91	13, 79	MR-LS2	9MR-LS2	
1971-77	4	124, 125 Special, 127 Berlina	Marelli S134, S144, S145, S146, S147	13, 72, 79	MR-LS1	9MR-LS1	
1972-77	4	132 Berlina, Berlina Special, GL	Marelli S134, S144, S147	13, 79	MR-LS1	9MR-LS1	
1973-77	4	131	Marelli S144, S147	13, 79	MR-LS1	9MR-LS1	
All	4	X19	Marelli S135	79	MR-145	9MR-145	
All	4	X19	Marelli S155, S156	79	MR-142A	9MR-142A	
1975-77	4	132 GL, GLS	Marelli S134, S137, S144, S147	13, 79	MR-LS1	9MR-LS1	
1975-78	4	241 T, 242	Marelli S147	13, 79	MR-LS1	9MR-LS1	
1976-78	4	238B, Bi, 850 T	Marelli S147, S146	13, 79	MR-LS1	9MR-LS1	
1965-69	6	1800B Berlina, 2300 Berlina Lusso	Marelli S96	13, 79	MR-LS2	9MR-LS2	
1965-69	6	Familia	Marelli S96	13, 79	MR-LS2	9MR-LS2	
FORD							
1941-42	4	All models	Ford	23, 56, 79, 86	1247	91247	
1941-42	4	All models	Ford	23, 31, 56, 79, 86	1247XT	91247XT	
1971-73	4	1600cc engine	Motorcraft	13, 79	1241LS	91241LS	
1971-74	4	2000cc engine	Bosch	79	1847V	91847V	71847V
1972-73	4	Courier 1800cc	Hitachi	8, 79	1741	91741	
1974	4	2300cc engine	Motorcraft	79	1243A	91243A	
1974	6	2.8L V-6 engine	Bosch	79	1862	91862	
1949-65	6	All models with Loadomatic Dist.	Ford	55, 56, 68, 79	1266	91266	
1956-65	6	All models w/o Loadomatic Dist.	Motorcraft	69, 79	1261	91261	
1949-74	6	All models (excluding V-6 engine)	Motorcraft	69, 79	1261	91261	
1966-74	6	All models	Motorcraft	69, 79	1261	91261	
1963-67	6	All models (excluding V-6 engine)	Ford	55, 56, 68, 79	1266	91266	
1974	6	Mustang	Bosch	79	1867A	91867A	
1932-41	8	All models	Ford	13, 72, 79, 86, 92, 108	1286LS	91286LS	
1942-47	6	All models	Ford IGA-12127, 5GA-12127	13, 95, 79	1265LS		
1942-48	8	Flat Head engine	Ford	13, 55, 56, 57, 72, 79, 95	1285LS	91285LS	
1949-52	8	Flat Head engine	Ducellier	13, 56, 109, 79	DU-181LS		
1949-53	8	Flat Head engine	Ford	55, 56, 57, 79	1283	91283	71283
1954-56	8	Y block engine	Ford	55, 56, 79	1282	91282	71282
1957-74	8	All models	Motorcraft	8, 79, 88, 102	1281	91281	71281
1960-72	8	All models	Motorcraft	10, 34, 79	1284	91284	71281D
1960-72	8	All models	Motorcraft	10, 33, 79	1281DV	91281DV	71281D
1974-76	8	All models	Motorcraft	2, 17, 79	FO-181	9FO-181	
1977-83	8	All models	Motorcraft	2, 20, 79	FO-182	9FO-182	
All	8	Flat Head engine	Lucas 40068F	10, 55, 56, 57, 79	LU-186	9LU-186	
FORD (EUROPE)							
1956-63	4	Consul	Lucas 25D4	33, 57, 79, 102	LU-142A	9LU-142A	7LU-142A
1964-66	4	Cortina Lotus	Lucas 23D4	34, 57, 79	LU-148	9LU-148	
1967	4	Taurus 12M, 15M	Bosch	33, 79	1847V	91847V	71847V
1956-67	4	Anglia	Lucas 25D4	57, 79, 102	LU-142A	9LU-142A	7LU-142A
1967-68	4	Taurus 17M, 20M	Bosch	79	1847V	91847V	71847V
1967-69	4	Corsair	Motorcraft	79	1248A	91248A	
1964-70	4	Cortina	Lucas 25D4	57, 79, 102	LU-142A	9LU-142A	7LU-142A
1966-72	4	Zephyr	Motorcraft	79	1248A	91248A	
1968-74	4	Escort 1600cc	Lucas 25D4	79, 102	LU-142A	9LU-142A	7LU-142A
1966-79	4	Capri, Escort	Motorcraft	79	1248A	91248A	
1972-79	4	Cortina, Consul	Motorcraft	79	1248A	91248A	
1975-79	4	Escort	Bosch	33, 79	1847V	91847V	71847V
1978-80	4	Cortina 2300	Bosch	33, 79	1847V	91847V	71847V
All	4	All models	Lucas 43D4, 45D, 59D	79	LU-143A	9LU-143A	7LU-143A
FRAZER							
1947-50	6	All models	Autolite IGS Series	13, 55, 56, 57, 79	2563LS	92563LS	
All	6	All models	Lucas DX6A	13, 22, 57, 79	LU-169LS	9LU-169LS	
GMC TRUCK							
1930-35	6	Truck	Delco 622S, 622Y, 639U	55, 56, 79	2162	92162	
1964-66	4	All models	Delco	79	1144A	91144A	
1939-62	6	All models	Delco	13, 16, 28, 55, 56, 57, 79	1168LS	91168LS	
1960-65	6	All models	Delco	19, 55, 79	1164	91164	
1964-74	6	All models	Delco	16, 27, 79	1162A	91162A	
1955-56	8	All models	Delco	16, 55, 79	1183	91183	
1957-74	8	All models	Delco	19, 72, 79, 102	1181	91181	71181
1957-74	8	All models	Delco	13, 19, 72, 79, 102	1181LS	91181LS	

NEW
NEW
NEW

Year	Cyl	Model	Distributor Notes	Footnotes	Ignitor	Ignitor II	Ignitor III
GRAHAM							
NEW	1930-39	6 All models	Delco 623S, 623A, 632Z, 622Z, 632F, 639K	55, 56, 79	2162	92162	
NEW	1929-31	8 All models	Delco 668J	10, 63, 103, 55, 79	2184	92184	
GRAHAM-PAIGE							
NEW	1929-30	6 All models	Delco 623E	55, 56, 79	2162	92162	
NEW	1930-31	8 All models	Delco 668D	10, 63, 103, 55, 79	2184	92184	
HEALEY							
	1948-54	4 All models	Lucas DKY4A	13, 56, 57, 79, 86	LU-146LS	9LU-146LS	
HILLMAN							
	1939-55	4 All models	Lucas DKYH4A	13, 56, 57, 79, 86	LU-146LS	9LU-146LS	
	1955-56	4 All models	Lucas DM2P4	13, 57, 70, 79	LU-241LS	9LU-241LS	
	1957-61	4 All models	Lucas DM2P4	57, 71, 79	LU-149	9LU-149	
	1962-73	4 All models	Lucas 25D4	57, 79, 102	LU-142A	9LU-142A	7LU-142A
	1974-79	4 All models	Lucas 45D4	79, 102	LU-143A	9LU-143A	7LU-143A
	1963-66	6 All models	Lucas 25D6	57, 79	LU-162A	9LU-162A	
HOLDEN							
	1953-63	6 FJ, FE, FC, FB, EK, EJ	Bosch	55, 86, 79	1864A	91864A	
HONDA							
	1973-79	4 Civic	Hitachi	79	1741	91741	
	1975-79	4 Accord, CVCC	Hitachi	79	1741	91741	
	1977-79	4 Prelude	Hitachi	79	1741	91741	
	1968-70	4 600 & 800	Denso 29100-093	14, 79	1647	91647	
HRG							
	1939-53	4 All models	Lucas DKY4A	13, 56, 57, 79, 86	LU-146LS	9LU-146LS	
HUDSON							
	1935-36	6 All models	Autolite IGB-4301	55, 56, 79	1568	91568	
	1937-47	6 All models	Autolite IGW Series	55, 56, 79	1568	91568	
	1948-50	6 All models	Autolite IGS Series	13, 55, 56, 57, 79	2563LS	92563LS	
	1950-55	6 All models	Autolite IAT Series	56, 79	1362	91362	
	1935-42	8 All models	Autolite IGP-4001, IGP-4008	56, 79	1585A	91585A	
	1946-47	8 All models	Autolite IGP-4008	56, 79	1585A	91585A	
	1948-52	8 All models	Autolite IGT-4204	56, 79	1587	91587	
HUMBER							
	1939-53	4 All models	Lucas DKYH4A	13, 56, 57, 79, 86	LU-146LS	9LU-146LS	
	1953-56	4 Hawk	Lucas DM2P4	13, 57, 70, 79	LU-241LS	9LU-241LS	
	1961-62	4 Hawk	Lucas DM2P4	57, 71, 79	LU-149	9LU-149	
	1962-70	4 Hawk, Sceptre	Lucas 25D4	57, 79, 102	LU-142A	9LU-142A	7LU-142A
	1946-53	6 All	Lucas DVXH6A	13, 24, 57, 79	LU-168LS	9LU-168LS	
	1954-62	6 Super Snipe	Lucas	57, 79	LU-165	9LU-165	
	1962-67	6 Imperial, Super Snipe	Lucas	57, 79	LU-162A	9LU-162A	
HUPMOBILE							
	1929-39	6 All models	Autolite IGC Series	55, 56, 79	1567A	91567A	
	1934-40	6 All models	Autolite IGB, IGW Series	55, 56, 79	1568	91568	
	1934-36	8 All models	Autolite IGP Series	56, 79	1585A	91585A	
HYUNDAI							
	1984-86	4 Pony, Stellar	Hitachi	5, 79	1741	91741	
	1986-94	4 1.5L Excel	Mitsubishi	4, 79	1944	91944	

FOOTNOTES

<p>2 Factory electronic ignition</p> <p>4 Non fuel injection models</p> <p>5 Canadian models only</p> <p>8 Single point distributor</p> <p>10 Dual point distributor</p> <p>13 Lobe sensor module</p> <p>14 European models only</p> <p>16 Mechanical advance under breaker plate</p> <p>17 Small cap distributor</p> <p>19 Mechanical advance at top of shaft</p> <p>20 Large cap distributor</p> <p>22 Clockwise rotation</p> <p>23 Front mount distributor</p> <p>24 Counter clockwise rotation</p>	<p>27 Screw down cap</p> <p>28 Clip down cap</p> <p>31 Remote mount coil conversion kit included</p> <p>33 Vacuum advance distributor</p> <p>34 Non vacuum advance distributor</p> <p>35 Special keeper no. MR-122K required for distributors without distributor cap</p> <p>55 Ignitor version available in 6V negative ground, add N6 suffix</p> <p>56 Ignitor version available in 6V positive ground, add P6 suffix</p> <p>57 Ignitor version available in 12V positive ground, add P12 suffix</p> <p>63 With four lobe point cam</p> <p>68 Overhead view of Ford distributor shaft</p> <p>69 Overhead view of Motorcraft distributor shaft</p> <p>70 Early DM2 distributor with two piece point set</p>	<p>71 Late DM2 distributor with one piece point set</p> <p>72 Fit both single point and dual point distributors</p> <p>79 Not for use with solid core spark plug wires</p> <p>86 Requires modification to distributor</p> <p>88 Ignitor III kit only fits 1960-1974 Motorcraft distributors</p> <p>92 Disassembly of distributor required</p> <p>95 2 bolt front mount distributor</p> <p>102 Complete "Stock-Look" distributors available on page 47-50</p> <p>103 Kit contains two modules for dual coil application</p> <p>108 Dome style distributor with attached coil</p> <p>109 French Flathead Model</p>
--------------------------------------------------------------------------------------------------------------------------------------------------------------------------------------------------------------------------------------------------------------------------------------------------------------------------------------------------------------------------------------------------------------------------------------------------------------------------------------------------------	--------------------------------------------------------------------------------------------------------------------------------------------------------------------------------------------------------------------------------------------------------------------------------------------------------------------------------------------------------------------------------------------------------------------------------------------------------------------------------------------------------------------------------------------------------------------------------------------------------------------------------------------------------------------------------------------------------------	------------------------------------------------------------------------------------------------------------------------------------------------------------------------------------------------------------------------------------------------------------------------------------------------------------------------------------------------------------------------------------------------------------------------------------------------------------------------------------------------------------------------------------------------------------------------------------------------------------------

Year	Cyl	Model	Distributor Notes	Footnotes	Ignitor	Ignitor II	Ignitor III
IHC TRUCK							
NEW 1928-41	4	Truck	Delco 625F, 629K, 629T, 635J, 629U, 629V	55, 56, 79	2142	92142	
1957-64	4	All models	Lucas 25D4	57, 79, 102	LU-142A	9LU-142A	7LU-142A
1961-80	4	All models	Delco	19, 79	1141	91141	
1967-72	4	All models	Holley	39, 79	HO-141	9HO-141	
1967-72	4	All models	Holley	40, 79, 83	HO-142	9HO-142	
1972-74	4	All models	Prestolite	79	1441A		
1974-79	4	All models	Prestolite	2, 79	1441A		
1974-79	4	All models	Holley	2, 22, 79	HO-143	9HO-143	
NEW 1932-41	6	All models	Delco 622K, M, N, R, 623G, T, 639T	55, 56, 79	2162	92162	
1950-66	6	All models	Delco	13, 36, 40, 55, 56, 57, 79	1168LS	91168LS	
1967-80	6	All models	Delco	79	1162A	91162A	
1959-64	8	266-345 cid. engine	Delco	19, 72, 79	1181	91181	71181
1964-83	8	All models	Holley	22, 33, 79	1481	91481	
1964-83	8	All models	Holley	22, 33, 79, 83	HO-182	9HO-182	
1964-70	8	All models	Holley	24, 79	1482	91482	
1964-83	8	All models	Prestolite	22, 33, 79	1483A	91483A	
1972-81	8	266-345 engines	Holley	2, 22, 79, 96	HO-181	9HO-181	7HO-181
1972-81	8	404, 446 cid. engines	Holley	2, 24, 79, 96	HO-183	9HO-183	
1974-83	8	All models	Prestolite	2, 33, 79, 38	1483A	91483A	
1974-83	8	404, 446 cid. engines	Prestolite	33, 38, 79	1484A	91484A	
1974-83	8	All models	Prestolite IDN-4007	2, 34, 79	1485A	91485A	
INDIANA TRUCK							
NEW 1936-37	4	Truck	Delco 625H	55, 56, 79	2142	92142	
NEW 1936-37	6	All models	Delco 623J	55, 56, 79	2162	92162	
JAGUAR							
1939-48	4	All models	Lucas DKY4A	13, 56, 57, 79, 86	LU-146LS	9LU-146LS	
1949-57	6	All models	Lucas DVX6A, DVXH6A	13, 24, 57, 79, 86	LU-168LS	9LU-168LS	
1956-63	6	All models	Lucas DMBZ6A	57, 79	LU-165	9LU-165	
1964-74	6	All models	Lucas 22D6	57, 79	LU-166A	9LU-166A	
1968-69	6	All models	Lucas 25D6	57, 79	LU-162A	9LU-162A	
1975-76	6	XJ6	Lucas 45DE6	2, 79, 102	LU-161	9LU-161	
1977-84	6	XJ6	Lucas 45DM6	2, 79, 102	LU-167	9LU-167	
1971-81	12	XJ12, XJS, E-Type	Lucas 36DE12	2, 4, 79	LU-1122A	9LU-1122A	
1982-84	12	XJ12HE, XJSHE	Lucas 36DM12	2, 4, 79	LU-1121A	9LU-1121A	
JEEP							
1960-71	4	All models	Prestolite IAY-4401	55, 79	1548	91548	
1959-60	4	All models	Delco 1110225	79	1144A	91144A	
1940-59	4	All models	Autolite IAD-4008	55, 79	2541	92541	
1966-74	6	All models	Delco	16, 79	1162A	91162A	
1967-69	6	All models	Delco 1110376	19, 43, 79	1165		
1960-65	6	All models	Auto/Prestolite IAT-4416, IAT-4404	79, 86	2561	92561	
1966-74	8	All models	Delco	19, 72, 79	1181	91181	71181
JENSEN							
1956-57	6	All models	Lucas DVX6A	13, 24, 57, 79, 86	LU-168LS	9LU-168LS	
1957-63	6	All models	Lucas DM6	57, 79	LU-165	9LU-165	
JENSEN-HEALEY							
1972-75	4	All models	Lucas 25D4	55, 79, 102	LU-142A	9LU-142A	7LU-142A
1975-76	4	All models	Lucas 45D4	79, 102	LU-143A	9LU-143A	7LU-143A
JOWETT							
1939-52	4	All models	Lucas DKY4A, DKYH4A	13, 56, 57, 79, 86	LU-146LS	9LU-146LS	
1953-54	4	All models	Lucas DM2P4	13, 57, 70, 79	LU-241LS	9LU-241LS	
KISSEL							
NEW 1929-31	8	All models	Delco 668B	10, 63, 103, 79	2184	92184	
KAISER							
1947-51	6	All models	Autolite IGS Series	13, 55, 56, 57, 79	2563LS	92563LS	
1951-55	6	All models	Delco 1110224	55, 56, 79	2161	92161	
LAMBORGHINI							
1973-79	8	Urraco	Marelli S127E	14, 59, 63, 79, 85	MR-184	9MR-184	
1964-68	12	350, 400	Marelli S85B, C, CA	10, 24, 60, 61, 64, 79, 85	MR-1123	9MR-1123	
1964-68	12	350, 400	Marelli S85B, C, CA	10, 24, 60, 61, 64, 79, 85	MR-1123	9MR-1123	
1966-73	12	Miura	Marelli S85B, C, CA	10, 24, 60, 61, 64, 79, 85	MR-1123	9MR-1123	
1968-78	12	Espada	Marelli S85B, C, CA	10, 24, 60, 61, 64, 79, 85	MR-1123	9MR-1123	
1970-76	12	Jarama	Marelli S85B, C, CA	10, 24, 60, 61, 64, 79, 85	MR-1123	9MR-1123	
1970-76	12	Jarama	Marelli S129G	14, 24, 59, 64, 79, 85	MR-1125	9MR-1125	
1981-88	12	Jalpa	Marelli S85B, C, CA	10, 24, 60, 61, 64, 79, 85	MR-1123	9MR-1123	
1974-89	12	Countach	Marelli S85B, C, CA	10, 24, 60, 61, 64, 79, 85	MR-1123	9MR-1123	
LANCIA							
1964-69	4	Flavia Coupe	Marelli S139	13, 79	MR-LS1	9MR-LS1	
1964-69	4	Berlina	Marelli S105	13, 79	MR-LS2	9MR-LS2	
1965-70	4	Flavia, Fulvia GT	Marelli S102, S105	13, 79	MR-LS2	9MR-LS2	
1965-70	4	Rallye, Sport, Sport Coupe	Marelli S102, S105	13, 79	MR-LS2	9MR-LS2	
1950-59	6	Aurelia,	Marelli S53C	10, 64, 79	MR-163	9MR-163	

Year	Cyl	Model	Distributor Notes	Footnotes	Ignitor	Ignitor II	Ignitor III
LA SALLE							
1932-35	8	All models	Delco 660, 662	10, 63, 56, 79	2181	92181	
1940-42	8	All models	Delco	16, 55, 79	1183	91183	
LEA FRANCIS							
1939-54	4	All models	Lucas DKY4A, DKYH4A	13, 56, 57, 79, 86	LU-146LS	9LU-146LS	
LINCOLN							
NEW 1932-41	8	All models	Ford	13, 72, 86, 92, 108, 79	1286LS	91286LS	
1942-48	8	All models w / Flathead engine	Ford	13, 55, 56, 57, 79, 95	1285LS	91285LS	
1949	8	All models	Autolite	56, 79	1587	91587	
1950-51	8	All models w / Flathead engine	Ford	55, 56, 57, 79	1283	91283	71283
1952-56	8	All models w / Y Block engine	Ford	55, 56, 79	1282	91282	71282
1957-73	8	All models	Motorcraft	79	1281	91281	71281
1974-76	8	All models	Motorcraft	2, 17, 79	FO-181	9FO-181	
1977-83	8	All models	Motorcraft	2, 20, 79	FO-182	9FO-182	
1932-40	12		Autolite IGM-4002	79	15121		
LOTUS							
1959-65	4	Elite	Lucas D3AH4A	24, 57, 79	LU-145	9LU-145	
1964-73	4	Elan	Lucas 23D4	34, 57, 79	LU-148	9LU-148	
1967-73	4	Seven	Lucas 25D4	57, 79	LU-142A	9LU-142A	7LU-142A
1970-75	4	Europra	Lucas 23D4	34, 79	LU-148	9LU-148	
1974-79	4	Eclat, Elite, Esprit	Lucas 25D4	79	LU-142A	9LU-142A	7LU-142A
1977-79	4	Eclat, Elite, Esprit	Lucas 43D4, 45D, 59D	79	LU-143A	9LU-143A	7LU-143A
MAZDA (NON ROTARY)							
1970-71	4	1200, 1500	Hitachi	79	1741	91741	
1970-74	4	1800	Hitachi	79	1741	91741	
1971-72	4	616 (1600cc) 808	Hitachi	9, 79	1741	91741	
1972-73	4	1600cc	Hitachi	7, 79	1741	91741	
1972-74	4	B1600, 616, 618	Hitachi	79	1741	91741	
1972	4	618 (1800cc)	Hitachi	6, 79	1741	91741	
1973	4	618 (1800cc)	Hitachi	79	1741	91741	
1987-88	4	B2600	Mitsubishi	79	1944	91944	
MASERATI							
NEW 1966-76	8		Bosch 231127004	10, 64, 79	1884	91884	
All	8	3500 GT	Marelli S109A	10, 62, 85, 79, 103	MR-164		
MERCEDES							
1955-66	4	190 Series	Bosch	34, 55, 79	1844	91844	
1959-65	4	190 Series	Bosch VJU4BR8, 23115027, 052	33, 55, 79	2843	92843	
1966-67	4	200 Series	Bosch 231170138	79	1847V	91847V	71847V
1966-67	4	200 Series	Bosch VJU4BR8, 23115027, 052	79	2843	92843	
1972-73	4	220	Bosch	79	1847V	91847V	71847V
1974-77	4	230, 240	Bosch	79	1847V	91847V	71847V
1958-62	6	300 Roadster	Bosch ZV / PCS 6 R 1T	10, 64, 79	2866	92866	
1961-62	6	300D	Bosch 231116040	55, 79	1864A	91864A	
1962-67	6	300SE	Bosch 231141002 (ZV/PB 6R1T)	10, 64, 79	2865	92865	
1965	6	220SE	Bosch 231116040	55, 79	1864A	91864A	
1966-67	6	230SL	Bosch 231116051	55, 79	1864LA	91864LA	
1966-67	6	230, S	Bosch 231116048	55, 79	1864A	91864A	
1967	6	250SE	Bosch 231116051	79	1864LA	91864LA	
1968-69	6	280SE, SL, 300SEL	Bosch 231116051	79	1864LA	91864LA	
NEW 1970-71	8	280SE, 300SEL	Bosch 231302002	2, 13, 79	1887LS	91887LS	
NEW 1974-78	8	450SE, SEL, SL, SLC	Bosch 231403007 / 006	2, 13, 79	1887LS	91887LS	
1970	6	280SE, SEL	Bosch 231116061	79	1863	91863	
1970	6	250C, 280S	Bosch 231116062	79	1863	91863	
1973-74	6	280	Bosch 231310002	79	2861	92861	
1975-76	6	280	Bosch 231311001	79	1868	91868	
1953-54	8	300SL	Bosch ZVLBUR 8 R2	10, 63, 79	1884	91884	
1968-71	8	300SEL, 600	Bosch 231119004	10, 63, 79	1884	91884	
1970	8	600	Bosch 231119008	79	1885	91885	
1972	8	280SE, SEL, 300SEC, 350SL	Bosch	79	1885	91885	
NEW 1973-75	8	450SEL	Bosch	2, 13, 79	1887LS	91887LS	

FOOTNOTES

- | | | |
|------------------------------------------------------------------------------------------------------------------------------------------------------------------------------------------------------------------------------------------------------------------------------------------------------------------------------------------------------------------------------------------------------------------------------------------------------------------------------------------------------------------------------------------------------------------------------------------|----------------------------------------------------------------------------------------------------------------------------------------------------------------------------------------------------------------------------------------------------------------------------------------------------------------------------------------------------------------------------------------------------------------------------------------------------------------------------------------------------------------------------------------------------------------------------------------------------------------------------------------------------------------------------------------------------------------------------------------------------------|-----------------------------------------------------------------------------------------------------------------------------------------------------------------------------------------------------------------------------------------------------------------------------------------------------------------------------------------------------------------------------------------------------------------------------------------------------------------------------------------------------------------------------------------------------------------------------------------------------------------------------------------------------------------------------------------------------------------------------------------------------------------------------------------------------|
| <ul style="list-style-type: none"> 2 Factory electronic ignition 4 Non fuel injection models 6 California models only 7 Manual trans only 9 Excluding California model with auto trans 10 Dual point distributor 13 Lobe sensor module 14 European models only 16 Mechanical advance under breaker plate 17 Small cap distributor 19 Mechanical advance at top of shaft 20 Large cap distributor 22 Clockwise rotation 24 Counter clockwise rotation | <ul style="list-style-type: none"> 33 Vacuum advance distributor 34 Non vacuum advance distributor 36 Excluding distributor number 112314 38 Excluding distributor number idn-4007 39 With "curved" point set 40 With "straight" point set 43 Odd fire engine 55 Ignitor version available in 6V negative ground, add N6 suffix 56 Ignitor version available in 6V positive ground, add P6 suffix 57 Ignitor version available in 12V positive ground, add P12 suffix 59 Single distributor applications 60 Dual distributor applications 61 Kit contains one module for each distributor 62 With six lobe point cam | <ul style="list-style-type: none"> 63 With four lobe point cam 64 With three lobe point cam 70 Early DM2 distributor with two piece point set 72 Fit both single point and dual point distributors 79 Not for use with solid core spark plug wires 83 With plastic sliding point plate 85 Point cam felt bracket removal required 86 Requires modification to distributor 92 Disassembly of distributor required 95 2 bolt front mount distributor 96 With factory Holley gold box ignition 102 Complete "Stock-Look" distributors available on page 47-50 103 Kit contains two modules for dual coil application 108 Dome style distributor with attached coil |
|------------------------------------------------------------------------------------------------------------------------------------------------------------------------------------------------------------------------------------------------------------------------------------------------------------------------------------------------------------------------------------------------------------------------------------------------------------------------------------------------------------------------------------------------------------------------------------------|----------------------------------------------------------------------------------------------------------------------------------------------------------------------------------------------------------------------------------------------------------------------------------------------------------------------------------------------------------------------------------------------------------------------------------------------------------------------------------------------------------------------------------------------------------------------------------------------------------------------------------------------------------------------------------------------------------------------------------------------------------|-----------------------------------------------------------------------------------------------------------------------------------------------------------------------------------------------------------------------------------------------------------------------------------------------------------------------------------------------------------------------------------------------------------------------------------------------------------------------------------------------------------------------------------------------------------------------------------------------------------------------------------------------------------------------------------------------------------------------------------------------------------------------------------------------------|

Year	Cyl	Model	Distributor Notes	Footnotes	Ignitor	Ignitor II	Ignitor III
MERCURY							
1971-72	4	All models 98 cid. engine (1600cc)	Motorcraft	13, 79	1241LS	91241LS	
1971-74	4	All models 122 cid. engine (2000cc)	Bosch	33, 79	1847V	91847V	71847V
1974	4	All models 140 cid. engine (2300cc)	Motorcraft	79	1243A	91243A	
1949-65	6	All models with Loadomatic Dist.	Ford	55, 56, 68, 79	1266	91266	
1956-65	6	All models w/o Loadomatic Dist.	Motorcraft	69, 79	1261	91261	
1958-74	6	All models	Motorcraft	69, 79	1261	91261	
1966-74	6	All models	Motorcraft	69, 79	1261	91261	
1972-74	6	All models	Bosch	79	1867A	91867A	
1949-53	8	All models flathead	Motorcraft	55, 56, 57, 79	1283	91283	71283
1954-56	8	All models Y block	Motorcraft	55, 56, 79	1282	91282	71282
1960-73	8	All models	Motorcraft	10, 34, 79	1284	91284	71281D
1960-73	8	All models	Motorcraft	10, 33, 79	1281DV	91281DV	71281D
1957-74	8	All models	Motorcraft	8, 79, 88	1281	91281	71281
1974-76	8	All models	Motorcraft	2, 17, 79	FO-181	9FO-181	
1977-83	8	All models	Motorcraft	2, 20, 79	FO-182	9FO-182	
METROPOLITAN							
1954-55	4	540	Lucas DM2P4	13, 57, 70, 79	LU-241LS	9LU-241LS	
1955-64	4	560, 1500	Lucas DM2P4	57, 71, 79	LU-149	9LU-149	
MG							
1946-52	4	TC, TD	Lucas DKY4A,	41, 56, 57, 79	LU-146		
1946-52	4	TC, TD	Lucas DKY4A	37, 42, 56, 57, 79	LU-146M		
1946-53	4	All models	Lucas DKY4A, DKYH4A	13, 56, 57, 79, 86	LU-146LS	9LU-146LS	
1956-62	4	All models	Lucas DM2P4	57, 71, 79	LU-149	9LU-149	
All	4	MGA twin cam	Lucas 23D4	34, 57, 79	LU-148	9LU-148	
1963-74	4	MGB, Midget	Lucas 25D4	57, 79, 102	LU-142A	9LU-142A	7LU-142A
1967	4	Midget	Lucas 23D4	34, 57, 79	LU-148	9LU-148	
All	4	All models	Lucas 43D4, 45D, 59D	34, 79	LU-143A	9LU-143A	7LU-143A
1975-80	4	Midget, MGB	Lucas 45DE4 45DM4	2, 79, 102	LU-147A	9LU-147A	
1968-69	6	MGC	Lucas 25D6	57, 79	LU-162A	9LU-162A	
1972-76	8	MGB GT V8	Lucas 35D8		LU-181A	9LU-181A	
MILITARY VEHICLES							
All	4	M39, M151 and M422	AutoLite IAU Series	66, 67, 79	MV-141A		
All	6	M37, M38, M715	AutoLite IAU Series	66, 67, 79	MV-161A		
MINI							
1965-71	4	Cooper S	Lucas 23D4	34, 79	LU-148	9LU-148	
1979-on	4	Cooper	Lucas 43D4, 59D4	79	LU-143A	9LU-143A	
MITSUBISHI							
1984-89	4	2.6L Montero, Pickup	Mitsubishi	2, 79	1944	91944	
1985-88	4	1.5L Mirage	Mitsubishi	2, 79	1944	91944	
1987-89	4	1.5L Precis	Mitsubishi	2, 79	1944	91944	
MORGAN							
1939-54	4	All models	Lucas DKH4A, DKYH4A, DKY4A	13, 56, 57, 79, 86	LU-146LS	9LU-146LS	
1955-59	4	Plus Four	Lucas DM2P4	13, 57, 70, 79	LU-241LS	9LU-241LS	
1960-63	4	Plus Four	Lucas DM2P4	57, 71, 79	LU-149	9LU-149	
1963-66	4	Plus Four	Lucas 25D4	57, 79	LU-142A	9LU-142A	7LU-142A
1970-74	8	Plus Eight	Lucas 35D8	79	LU-181A	9LU-181A	
1976-82	8	Plus Eight	Lucas 35DE8, 35DM8	2, 79	LU-281	9LU-281	
MORRIS							
1939-53	4	All models	Lucas DKH4A, DKYH4A, DKY4A	13, 56, 57, 79, 86	LU-146LS	9LU-146LS	
1957-62	4	Minor 1000	Lucas DM2P4	57, 71, 79	LU-149	9LU-149	
1963-74	4	All models	Lucas 25D4	79, 102	LU-142A	9LU-142A	7LU-142A
1974-75	4	All models	Lucas 45D4	79, 102	LU-143A	9LU-143A	
NASH							
NEW 1928-32	6	600	Delco 1110512	55, 56, 79	2162	92162	
1935-36	6	All models	AutoLite IGB Series	55, 56, 79	1568	91568	
1938	6	All models	AutoLite IGC Series	55, 56, 79	1567A	91567A	
1939-42	6	All models	AutoLite IGS Series	13, 55, 56, 57, 79	2563LS	92563LS	
1946-48	6	All models	AutoLite IGS Series	13, 55, 56, 57, 79	2563LS	92563LS	
1947-48	6	All models	AutoLite IGB Series	55, 56, 79	1568	91568	
1951-55	6	All models	Delco	13, 36, 40, 55, 56, 57, 79	1168LS	91168LS	
1942	8		AutoLite IGT-4202	56, 79	1587	91587	
NISSAN / DATSUN							
1977	4	F10, 200SX, B-210, 620 Truck, 710	Hitachi	79	1741	91741	
1966-67	4	411	Hitachi	79	1741	91741	
1966-69	4	520 Truck, 521 Truck	Hitachi	79	1741	91741	
1968-69	4	510	Hitachi	8, 79	1741	91741	
1967-70	4	311	Hitachi	8, 79	1741	91741	
1971-73	4	B-110	Hitachi	79	1741	91741	
1974-76	4	B-210, 610, 620 Truck, 710	Hitachi	79	1741	91741	
1979-80	4	210 A12 engine	Hitachi	79	1741	91741	
All	6	L60 LG60 KL60 Patrol	Hitachi	13, 67, 79	1763LS	91763LS	
1970-73	6	240Z	Hitachi	8, 79	1761	91761	

Year	Cyl	Model	Distributor Notes	Footnotes	Ignitor	Ignitor II	Ignitor III
OLDSMOBILE							
1967-73	4	All models	Bosch	33, 79	1847V	91847V	71847V
NEW 1927-35	6	All models	Delco 632P, 639G, 622S, 622Y, 629Y	55, 56, 79	2162	92162	
1948-49	6	All models	Delco 1110214, 1110221	79	2161	92161	
1964-65	6	All models V-6	Delco	19, 43, 79	1165		
1966-74	6	All models	Delco	16, 79	1162A	91162A	
1929	8		Delco 658T	10, 56, 57, 63, 79	2183	92183	
1932-35	8	All models	Delco 660, 662	10, 63, 56, 79	2181	92181	
1940-55	8	All models	Delco	16, 55, 79, 90	1183	91183	
1940-55	8	All models	Delco	13, 16, 79	1187LS		
1956-74	8	All models	Delco	19, 72, 79	1181	91181	71181
1956-74	8	All models	Delco	13, 18, 19, 79	1181LS	91181LS	71181
OPEL							
1966-74	4	Kadett	Bosch	33, 79	1847V	91847V	71847V
1968-75	4	GT 1900	Bosch	33, 79	1847V	91847V	71847V
1972-75	4	Manta	Bosch	33, 79	1847V	91847V	71847V
1975	4	1900	Bosch	33, 79	1847V	91847V	71847V
PACKARD							
1937-39	6	All models	Autolite IGS Series	13, 55, 56, 57, 79	2563LS	92563LS	
1940	6	110	Autolite IGW-4143	56, 79	1568	91568	
1940-47	6		Autolite IGC Series	55, 56, 79	1567A	91567A	
1933-34	8	Eight, Super Eight	North East 5033450	57, 63, 79, 103	NE-181		
1935-36	8	All models	Delco 662	10, 56, 63, 79	2181	92181	
1937-50	8	All models	Autolite IGT Series	56, 79	1587	91587	
1940-54	8	All models	Autolite IGP Series	56, 79	1585A	91585A	
1948-55	8	Custom Clipper, 5560, 5580	Delco 1110854, 084	16, 55, 79	1183	91183	
PANTERA							
1971-72	8	All models	Motorcraft	5, 79	1281	91281	71281
1972-74	8	All models	Motorcraft	10, 79	1284	91284	71281D
PEERLESS							
NEW 1929-30	6	All models	Delco 631F	55, 56, 79	2162	92162	
PEUGEOT							
1957-78	4	All models	Ducellier	55, 79	EP-141		
1957-78	4	All models	SEV	79	SV-142	9SV-142	
PIERCE ARROW							
NEW 1929-31	8	All models	Delco 668E	10, 63, 79, 103	2184	92184	
1931-37	8	All models	Delco 660, 662	10, 63, 56, 79	2181	92181	
PLYMOUTH							
NEW 1928-29	4		Delco 630B, 635T	55, 56, 79	2142	92142	
NEW 1930-32	4	PA, PB, U	Delco 629A, 629H, 629M	55, 56, 79	2142	92142	
1980	4	1400cc, 1600cc	Hitachi	1, 79	1741	91741	
1976-79	4	All models	Mitsubishi	79	1942	91942	
NEW 1928-34	6	All models	Delco 622H, 622U	55, 56, 79	2162	92162	
1933-34	6	All models	Delco	13, 36, 40, 55, 56, 57, 79	1168LS	91168LS	
1935-42	6	All models	Autolite IGS Series	13, 55, 56, 57, 79	2563LS	92563LS	
1946-50	6	All models	Autolite IGS, IAP Series	13, 55, 56, 57, 79	2563LS	92563LS	
1960-72	6	All models	Chrysler	8, 79	1361A	91361A	
1973-81	6	All models	Chrysler	2, 15, 79	CH-161	9CH-161	
1955-58	8	All models	Autolite IBK, IAZ Series	10, 56, 79	1385	91385	71385
1957-62	8	All models	Autolite IBP Series	8, 79	1385	91385	71385
1959-71	8	383-440 cid. engine (including Hemi)	Auto/Prestolite IBS Series	10, 79	1385	91385	71385
1959-72	8	All models	Chrysler	8, 79, 102	1381A	91381A	71381A
1968-73	8	340 six pack engine	Prestolite	79	1384	91384	
1972-81	8	All models	Chrysler	2, 15, 79	CH-181	9CH-181	

FOOTNOTES

- | | | |
|-----------------------------------------------------------------------------------------------------------------------------------------------------------------------------------------------------------------------------------------------------------------------------------------------------------------------------------------------------------------------------------------------------------------------------------------------------------------------------------------------------------------------------------------------------------|-----------------------------------------------------------------------------------------------------------------------------------------------------------------------------------------------------------------------------------------------------------------------------------------------------------------------------------------------------------------------------------------------------------------------------------------------------------------------------------------------------------------------------------------------------------------------------------------------------------------------------------------------------------------------------------------------------------------|------------------------------------------------------------------------------------------------------------------------------------------------------------------------------------------------------------------------------------------------------------------------------------------------------------------------------------------------------------------------------------------------------------------------------------------------------------------------------------|
| <p>1 Excluding California models</p> <p>2 Factory electronic ignition</p> <p>5 Canadian models only</p> <p>8 Single point distributor</p> <p>10 Dual point distributor</p> <p>13 Lobe sensor module</p> <p>15 Excluding lean burn computer controlled engines</p> <p>16 Mechanical advance under breaker plate</p> <p>17 Small cap distributor</p> <p>18 Excluding 215 and 300 cid. engine</p> <p>19 Mechanical advance at top of shaft</p> <p>20 Large cap distributor</p> <p>33 Vacuum advance distributor</p> <p>34 Non vacuum advance distributor</p> | <p>36 Excluding distributor number 1112314</p> <p>37 With asymmetric point cam</p> <p>40 With "straight" point set</p> <p>41 Distributor with part number suffix from E-Z</p> <p>42 Distributor with part number suffix from A-D</p> <p>43 Odd fire engine</p> <p>55 Ignitor version available in 6V negative ground, add N6 suffix</p> <p>56 Ignitor version available in 6V positive ground, add P6 suffix</p> <p>57 Ignitor version available in 12V positive ground, add P12 suffix</p> <p>63 With four lobe point cam</p> <p>66 24-volt system</p> <p>67 Mil-Spec Waterproof Ignition</p> <p>69 Overhead view of Motorcraft distributor shaft</p> <p>70 Early DM2 distributor with two piece point set</p> | <p>71 Late DM2 distributor with one piece point set</p> <p>72 Fit both single point and dual point distributors</p> <p>79 Not for use with solid core spark plug wires</p> <p>86 Requires modification to distributor</p> <p>88 Ignitor III kit only fits 1960-1974 Motorcraft distributors</p> <p>90 Excluding distributor number 1110824</p> <p>102 Complete "Stock-Look" distributors available on page 47-50</p> <p>103 Kit contains two modules for dual coil application</p> |
|-----------------------------------------------------------------------------------------------------------------------------------------------------------------------------------------------------------------------------------------------------------------------------------------------------------------------------------------------------------------------------------------------------------------------------------------------------------------------------------------------------------------------------------------------------------|-----------------------------------------------------------------------------------------------------------------------------------------------------------------------------------------------------------------------------------------------------------------------------------------------------------------------------------------------------------------------------------------------------------------------------------------------------------------------------------------------------------------------------------------------------------------------------------------------------------------------------------------------------------------------------------------------------------------|------------------------------------------------------------------------------------------------------------------------------------------------------------------------------------------------------------------------------------------------------------------------------------------------------------------------------------------------------------------------------------------------------------------------------------------------------------------------------------|



Ignitor
Ignitor II
Ignitor III

Year	Cyl	Model	Distributor Notes	Footnotes	Ignitor	Ignitor II	Ignitor III
PONTIAC							
1961-62	4	All models	Delco 1110254, 261, 282, 283	19, 79	1141	91141	
1962-63	4	All models	Delco 1110284, 285, 300	16, 79	1144A	91144A	
NEW 1928-32	6	All models	Delco 639J	55, 56, 79	2162	92162	
1946-54	6	All models	Delco	13, 36, 40, 55, 56, 57, 79	1168LS	91168LS	
1948-50	6	All models	Delco 1110219, 222, 223	79	2161	92161	
1962-74	6	All models	Delco	79	1162A	91162A	
1934-56	8	All models	Delco	16, 55, 56, 79	1183	91183	
1955-56	8	All models	Delco	13, 16, 79	1187LS		
1957-74	8	All models	Delco	19, 72, 79	1181	91181	71181
1957-74	8	All models	Delco	13, 18, 19, 79	1181LS	91181LS	71181
PORSCHE							
1976	4	912E	Bosch	33, 79	1847V	91847V	71847V
1955-66	4	356	Bosch 231129022	55, 79	1844	91844	
1955-66	4	356	Bosch 231129031	55, 79	2847	92847	
1966-67	4	912	Bosch 231129022	55, 79	1844	91844	
1966-67	4	912	Bosch 231129031	55, 79	2847	92847	
1968-69	4	912	Bosch	79	1843	91843	
1970-76	4	914	Bosch	33, 79	1847V	91847V	71847V
1976-77	4	924	Bosch 231170202, 176064	33, 79	1847V	91847V	71847V
All	6	906, 911 R	Marelli S121A, S121B	64, 79	MR-162	9MR-162	
1968	6	911L, T	Bosch	79	1863	91863	
1973	6	911, E, S, T May of 1973 & later	Bosch	79	1867A	91867A	
1974-77	6	911, 911S, Carrera	Bosch	79	1867A	91867A	
1965-67	6	911, S, T	Bosch	79	1866	91866	
1969-71	6	911, E, S, T	Bosch	79	2862	92862	
1969-71	6	911, E, S, T	Marelli S112AX	13, 79	MR-LS1	9MR-LS1	
1972-73	6	911, E, S, T up to May of 1973	Bosch	79	1863	91863	
1971	6	914-6	Bosch 231159008	79	2862	92862	
RELIANT							
1939	4	All models	Lucas DK4A	13, 56, 57, 79, 86	LU-146LS	9LU-146LS	
1962-63	4	Sabre	Lucas DM2P4	57, 71, 79	LU-149	9LU-149	
1964-66	4	Sabre	Lucas 25D4	56, 57, 79	LU-142A	9LU-142A	7LU-142A
1964-65	6	Sabre, Scimitar	Lucas 25D6	57, 79	LU-162A	9LU-162A	
REO							
NEW 1930-32	4	Truck	Delco 629J	55, 56, 79	2142	92142	
NEW 1931-36	6	Truck	Delco 623D, 632N, 632V	55, 56, 79	2162	92162	
1929-36	6	All models	Delco	13, 36, 40, 55, 56, 57, 79	1168LS	91168LS	
1931-34	8	All models	Delco 660	10, 63, 56, 79	2181	92181	
RENAULT							
1952-77	4	All models	Bosch	55, 79	1843	91843	
1952-77	4	All models	Ducellier	55, 79	EP-141		
1952-77	4	All models	SEV	55, 34, 79	SV-142	9SV-142	
RILEY							
1935-37	4	All models	Lucas DKY4A, DKYH4A	13, 56, 57, 79, 86	LU-146LS	9LU-146LS	
1948-54	4	All models	Lucas DKY4A, DKYH4A	13, 56, 57, 79, 86	LU-146LS	9LU-146LS	
1956-59	4	Pathfinder, L29	Lucas DM2P4	57, 71, 79	LU-149	9LU-149	
1963-70	4	1.5 Ltr. Elf, Saloon	Lucas 25D4	57, 79, 102	LU-142A	9LU-142A	7LU-142A
1967-70	4	Kestrel 1100, 1300	Lucas 25D4	57, 79, 102	LU-142A	9LU-142A	7LU-142A
1957-58	6	All models 2.6 Ltr.	Lucas DM6A	57, 79	LU-165	9LU-165	
ROLLS ROYCE							
All	6	All	Delco PO-6	10, 57, 64, 79	RR-162	9RR-162	
All	8	All models	Lucas 20D8	57, 79	RR-181	9RR-181	
All	8	All models	Delco DR-8N	63, 79	RR-182	9RR-182	
1963-65	8	Silver Cloud III	Lucas 35D8	79	LU-181A	9LU-181A	
1966-74	8	Corniche, Silver Shadow	Lucas 35D8	79	LU-181A	9LU-181A	
ROVER							
1939-48	4	All models	Lucas DKY4A	13, 56, 57, 79, 86	LU-146LS	9LU-146LS	
1948-53	4	Landrover	Lucas DM2P4	13, 57, 70, 79	LU-241LS	9LU-241LS	
1956-63	4	2 litre	Lucas DM2P4	57, 71, 79	LU-149	9LU-149	
1963-76	4	2 litre	Lucas 25D4	57, 102	LU-142A	9LU-142A	7LU-142A
1977-79	4	2 litre	Lucas 45D4	79, 102	LU-143A	9LU-143A	7LU-143A
1980-89	4	Landrover III	Ducellier 525232A	79	EP-142		
1952-59	6	90, 105	Lucas DM6A, DMBZ6A	57, 79	LU-165	9LU-165	
1955-59	6	75	Lucas DM6A, DMBZ6A	57, 79	LU-165	9LU-165	
1959-61	6	3 Litre	Lucas DM6A, DMBZ6A	57, 79	LU-165	9LU-165	
1959-62	6	100	Lucas DM6A, DMBZ6A	57, 79	LU-165	9LU-165	
1963-79	6	3 Litre	Lucas 25D6	57, 79	LU-162A	9LU-162A	
1967-76	8	3 Litre, 3.5L	Lucas 35D8	79, 102	LU-181A	9LU-181A	
1974-76	8	3500	Lucas 35DE8	2, 79, 102	LU-281	9LU-281	
1981-84	8	All	Lucas 35DM8	2, 79, 102	LU-281	9LU-281	

Year	Cyl	Model	Distributor Notes	Footnotes	Ignitor	Ignitor II	Ignitor III
SAAB							
1965-67	3	96, Monte Carlo	Bosch VJ 3BR11T, Q231120023	34, 79	1831		
1965-68	3	95, 96, Monte Carlo	Bosch 231144004, 231144003	33, 79	1832		
1967-72	4	Sonett V4	Bosch	33, 79	1847V	91847V	71847V
1970-74	4	99E, EA, EMS V4	Bosch Q231163007, 3025	33, 79	1847V	91847V	71847V
1972-74	4	Sonett III, 95, 96 V4	Bosch	33, 79	1847V	91847V	71847V
SIMCA							
1955-71	4	All models	Ducellier	79	EP-141		
1955-71	4	All models	SEV	79	SV-141	9SV-141	
SINGER							
1939-54	4	All models	Lucas DKY4A	13, 56, 57, 79, 86	LU-146LS	9LU-146LS	
1959-61	4	Gazelle	Lucas DM2P4	57, 71, 79	LU-149	9LU-149	
1962-63	4	Vogue	Lucas 25D4	57, 79, 102	LU-142A	9LU-142A	7LU-142A
STANDARD							
1939-49	4	All models	Lucas DKH4A, DKY4A, DKYH4A	13, 56, 57, 79, 86	LU-146LS	9LU-146LS	
1957-60	4	All models	Lucas DM2P4	57, 71, 79	LU-149	9LU-149	
STUDEBAKER							
NEW 1928-32	6	All Pass	Delco 632M, 632J	55, 56, 79	2162	92162	
NEW 1929-35	6	Truck	Delco 622B, 622A, 622X, 632J	55, 56, 79	2162	92162	
1929-30	6	All models	Delco	13, 36, 40, 55, 56, 57, 79	1168LS	91168LS	
1935-42	6	All models	Autolite IGB, IGW Series	55, 56, 79	1568	91568	
1942-50	6	All models	Autolite IGC Series	55, 56, 79	1567A	91567A	
1950-55	6	All models	Delco	36, 40, 55, 56, 57, 79	1168LS	91168LS	
1953	6	All models	Delco 1110220	79	2161	92161	
NEW 1959-64	6	All	Autolite IAT-4403, IAT-4403A	55, 79, 86	2561	92561	
1965-66	6	194, 230 cid. engine	Delco	79	1162A	91162A	
All	6	All models	Autolite IAT-4010	55, 56, 79, 84, 86	1569	91569	
NEW 1929-31	8	All models	Delco 668C	10, 63, 79, 103	2184	92184	
1929-31	8	All models	Delco 658Z	10, 56, 57, 63, 79	2183	92183	
1932-37	8	All models	Delco 660, 662	10, 63, 56, 79	2181	92181	
1960-61	8	Lark & Regal	Delco	19, 57, 72, 79	1181	91181	71181
1965-66	8	All models	Delco	19, 57, 72, 79	1181	91181	71181
All	8	All models	Prestolite IBS-4012	79	1584	91584	
STUTZ							
1931-34	8	All models	Delco 660	10, 63, 56, 79	2181	92181	
SUBARU							
1975	4	DL, GL	Hitachi	79	1741	91741	
1969-73	4	1000, 1100, 1300G	Hitachi	79	1741	91741	
1975-76	4	DL (1400cc)	Hitachi	79	1741	91741	
SUNBEAM							
1945-50	4	Talbot	Lucas DKH4A, DKYH4A	13, 56, 57, 79, 86	LU-146LS	9LU-146LS	
1953-54	4	Talbot 90	Lucas DM2P4	13, 57, 70, 79	LU-241LS	9LU-241LS	
1959-61	4	Alpine, Rapier	Lucas DM2P4	57, 71, 79	LU-149	9LU-149	
1966-68	4	Alpine	Lucas 25D4	57, 79, 102	LU-142A	9LU-142A	7LU-142A
1966-73	4	Rapier	Lucas 25D4	57, 79, 102	LU-142A	9LU-142A	7LU-142A
TOYOTA							
NEW 1964-70	4	Stout	Nippondenso	13, 79, 119	1648LS	91648LS	
NEW 1965-71	4	Hi-Lux	Nippondenso	13, 79, 119	1648LS	91648LS	
NEW 1965-70	4	Corona	Nippondenso	13, 79, 119	1648LS	91648LS	
NEW 1966-71	4	Crown	Nippondenso	13, 79, 119	1648LS	91648LS	
1968-70	4	Mark II	Nippondenso	13, 79, 119	1648LS	91648LS	
1971	4	Celica, Supra	Nippondenso	13, 79, 119	1648LS	91648LS	
1971-76	4	Corolla 1200, 1600	Nippondenso	8, 79	1641	91641	
1972-77	4	Carina, Celica, Corona	Nippondenso	8, 79	1641	91641	
NEW 1965-72	6	Crown	Nippondenso	79, 117	1662LS	91662LS	
NEW 1965-74	6	Landcruiser	Nippondenso	79, 118	1665A	91665A	
NEW 1972-76	6	Mark II	Nippondenso	79, 117	1662LS	91662LS	
NEW 1975-77	6	Landcruiser	Nippondenso	13, 79	1662LS	91662LS	

FOOTNOTES

<p>2 Factory electronic ignition 8 Single point distributor 10 Dual point distributor 13 Lobe sensor module 16 Mechanical advance under breaker plate 18 Excluding 215 and 300 cid. engine 19 Mechanical advance at top of shaft 33 Vacuum advance distributor 34 Non vacuum advance distributor 36 Excluding distributor number 1112314 40 With "straight" point set</p>	<p>55 Ignitor version available in 6V negative ground, add N6 suffix 56 Ignitor version available in 6V positive ground, add P6 suffix 57 Ignitor version available in 12V positive ground, add P12 suffix 63 With four lobe point cam 64 With three lobe point cam 70 Early DM2 distributor with two piece point set 71 Late DM2 distributor with one piece point set 72 Fit both single point and dual point distributors 79 Not for use with solid core spark plug wires 84 Ignitor version available in 24v negative ground add N24 suffix 86 Requires modification to distributor</p>	<p>102 Complete "Stock-Look" distributors available on page 47-50 103 Kit contains two modules for dual coil application 117 Non step point cam 118 Excluding CA 74 model 119 Early style distributor</p>
-------------------------------------------------------------------------------------------------------------------------------------------------------------------------------------------------------------------------------------------------------------------------------------------------------------------------------------------------------------------------------------------------------------------	------------------------------------------------------------------------------------------------------------------------------------------------------------------------------------------------------------------------------------------------------------------------------------------------------------------------------------------------------------------------------------------------------------------------------------------------------------------------------------------------------------------------------------------------------------------------------------------------------------------------------------	---------------------------------------------------------------------------------------------------------------------------------------------------------------------------------------------------------------------------

TRIUMPH							
1939-53	4	All models	Lucas DKH4A, DKY4A, DKYH4A	13, 56, 57, 79, 86	LU-146LS	9LU-146LS	
1955-62	4	All models	Lucas DM2P4	57, 71, 79	LU-149	9LU-149	
1962-67	4	All models	Lucas 25D4	57, 102, 79	LU-142A	9LU-142A	7LU-142A
All	4	All models	Delco D204, D200	53, 79	1149	91149	
1975-78	4	Spitfire	Lucas 45DE4	2, 79, 80	LU-147A	9LU-147A	
1979-80	4	TR7	Lucas 45DE4, 47DM4	2, 79, 80, 101	LU-147A	9LU-147A	
All	4	TR7	Delco D302-7992715	8, 13, 14, 53, 79	MR-LS2	9MR-LS2	
1962-75	6	All models	Lucas 22D6	57, 79	LU-166A	9LU-166A	
All	6	All models	Delco D204	53, 79	1169	91169	
1966-73	6	GT6	Delco D200	13, 79	2163LS	92163LS	
1970-77	8	Stag	Lucas 35D8	10, 32, 79	LU-181A	9LU-181A	
VANDEN PLUS							
1965-68	4	Princess 1100	Lucas 25D4	57, 79, 102	LU-142A	9LU-142A	7LU-142A
1968-72	4	Princess 1300	Lucas 25D4	57, 79, 102	LU-142A	9LU-142A	7LU-142A
1975	4	Princess 1500	Lucas 45D4	79	LU-143A	9LU-143A	7LU-143A
1961-63	6	3 Litre, 4 Litre	Lucas DM6	57, 79	LU-165	9LU-165	
1965-68	6	4 Litre	Lucas 25D6	57, 79	LU-162A	9LU-162A	
VAUXHALL							
1977-79	4	1300, 1600, 2000cc Cavalier	Bosch	33, 79	1847V	91847V	71847V
1958-72	6	All models	Delco	79	1169	91169	
VOLKSWAGEN							
1960-63	4	Bus (Type II)	Bosch ZV/PAU 4 R2	20, 55, 79	1845	91845	
1961-64	4	Type I	Bosch ZV/PAU 4 R2	20, 55, 79	1845	91845	
1964-67	4	Bus (Type II)	Bosch	55, 79	1849	91849	
1965-67	4	Beetle, Karmann Ghia (Type I)	Bosch	55, 79	1849	91849	
1966-67	4	Squareback, Fastback (Type III)	Bosch	55, 79	1849	91849	
1968-73	4	Squareback, Fastback (Type III)	Bosch	33, 79	1847V	91847V	71847V
1968-79	4	Beetle, Karmann Ghia (Type I)	Bosch	33, 79	1847V	91847V	71847V
1971-73	4	411 (Type IV)	Bosch	33, 79	1847V	91847V	71847V
1971-78	4	Bus (Type II)	Bosch	33, 79	1847V	91847V	71847V
1974	4	412 (Type IV)	Bosch	33, 79	1847V	91847V	71847V
1973-75	4	The Thing	Bosch	33, 79	1847V	91847V	71847V
1979	4	Bus (Type II)	Bosch	1, 33, 79	1847V	91847V	71847V
1980	4	Dasher, Jetta, Rabbit, Scirocco	Bosch	1, 33, 79	1847V	91847V	71847V
1975-79	4	Dasher, Rabbit, Scirocco	Bosch	33, 79	1847V	91847V	71847V
1980-83	4	Vanagon	Bosch	1, 33, 79	1847V	91847V	71847V
All	4	Aftermarket distributors	Bosch 0231-178-009, 9230-081-050	34, 79	1847A	91847A	71847A
VOLVO							
1966-68	4	122 Series	Bosch	79	2844	92844	
1966-68	4	1800S	Bosch	79	2844	92844	
1967-68	4	140 Series	Bosch	79	2844	92844	
1969-73	4	1800 Series	Bosch	33, 79	1847V	91847V	71847V
1969-74	4	140 Series	Bosch	33, 79	1847V	91847V	71847V
1982-83	4	240 Series	Bosch	5, 33, 79	1847V	91847V	71847V
1969-72	6	164 Series with B30A, B30B engine	Bosch 0231142001	79	1863	91863	
1973-75	6	164E Series with B30F engine	Bosch 0231301010	79	1869	91869	
WOLSELEY							
1939-53	4	All models	Lucas DKY4A	13, 56, 57, 79, 86	LU-146LS	9LU-146LS	
1958-73	4	All models	Lucas 25D4	57, 79, 102	LU-142A	9LU-142A	7LU-142A
1974-75	4	All models	Lucas 45D4	79	LU-143A	9LU-143A	7LU-143A
1956-63	6	All models	Lucas DM6	57, 79	LU-165	9LU-165	
1964-68	6	6/110	Lucas 25D6	57, 79	LU-162A	9LU-162A	
WILLYS							
1933-50	4	All models	Autolite IGB, IGW Series	55, 56, 79	1545	91545	
1951	4	All models	Autolite IGC Series	55, 56, 79	2541	92541	
1940-48	6	All models	Autolite IGC Series	55, 56, 79	1567A	91567A	
1954	6	All models	Autolite IAT Series	55, 56, 79, 86	1569	91569	

APPLICATIONS BY DISTRIBUTOR NUMBER

Ignitor, Ignitor II and Ignitor III kits are designed for specific distributor types and part numbers. Many of these kits are not identified by a particular vehicle make or model. If you can't find what you need in the application section of our catalog, use this look up. If its not here, that doesn't mean that we don't have it. If you are interested in a kit for a specific distributor please visit our website at www.pertronix.com or call (909) 547-9058.

Description	Cyl	Rotation	Footnotes	Ignitor	Ignitor II	Ignitor III
ACCEL						
NEW 30000 Series	8	CW / CCW	10, 13, 34, 79	AC-183LS	9AC-183LS	
34000 Series	8	CW / CCW	34, 79	AC-181	9AC-181	
34000 Series	8	CW / CCW	33, 79	AC-181V	9AC-181V	
37000 Series	8	CW / CCW	34, 79	AC-182A	9AC-182A	
AUTOLITE / PRESTOLITE						
IAM-4001 IAM-4010A IAO-4114A	6	CCW / CW	79	1567A	91567A	
IAP series	6	CW/CCW	13, 79	2563LS	92563LS	
IAT-4101 (Chrysler IND 33)	6	CW	79, 86	1362	91362	
IAT-4205	6	CCW	55, 56, 79, 86	1569		
IAU-4005UT, IAU-4007UT	6	CW	66, 67, 79	MV-161A		
IAU-4006AUT	4	CCW	66, 67, 79	MV-141A		
IAY-4009	6	CW	55, 56, 79	1564	91564	
IBM series	8	CW/CCW	28, 34, 50, 79	1581	91581	71581
IBM series	8	CW/CCW	27, 34, 49, 79	1582	91582	71582
IBM-7021	6	CW	79	1563B	91563B	
IBM-7026	4	CW	79	1546	91546	
IBT-4101	4	CCW	79	1544	91544	
IBT-4301D	3	CCW	79	1531		
IBT-6101	6		79	1566		
IBT-6701A	6	CCW	79	1566		
IDN-4009	4	CW	2, 79	1441A		
IDU-4015	2	CCW	79	1421		
IDU-4404, IDU-4407, IDU-4408, IDU-4409	4	CW/CCW	2, 79	2542	92542	
IDU-7602	6	CW	2, 79	2562	92562	
IDU-7801, IDU-7802	8	CW	2, 79	1589	91589	
IGS series	6	CW/CCW	13, 79	2563LS	92563LS	
IGW series	4	CW	56, 79, 120	1545	91545	
IGW-4113, IGW-4146	6	CW	55, 56, 79	1568	91568	
IGW-4199C (fires 180 degrees)	2	CCW	79	1521		
BOSCH						
231119004	8	CW	79	1884	91884	
231146026	4	CCW	79	1848	91848	
231155004	2	CW	33, 79	1821		
231178006	4	CW	79	2845	92845	
231178009	4	CW	79	1847A	91847A	71847A
231178017	4	CW	79	2842	92842	
231127004, 005, 006	8	CW	10, 63, 79	1884	91884	
231305091	6	CW	79	1869	91869	
231308009	6	CW	79	1862	91862	
231186023, 231146077, 231170307	4	CCW	79	1843	91843	
231301004, 231305058	6	CW	79, 84	2863	92863	
JF3 series VJ 3BR 4, VJ 3BR 11	3	CW	33, 79	1831		
JFU3 series VJ 3BR 2T, 0231114004	3	CW	34, 79	1832		
JFU4 series (Bosch) 22100B03G0 (Nissan)	4	CCW	79	2841	92841	
VJU 4BL 33	4	CCW	79	2846	92846	
ZV/LBUR 8 R2	8	CW	79	1884	91884	

FOOTNOTES

1 Excluding California models	36 Excluding distributor number 1112314	80 Excluding distributor number 41812A
2 Factory electronic ignition	40 With "straight" point set	84 Ignitor version available in 24v negative ground add N24 suffix
5 Canadian models only	49 Distributor with tapered style rotor	86 Requires modification to distributor
8 Single point distributor	50 Replacement rotor included	101 Excluding distributor number 41701A
10 Dual point distributor	53 Distributor marked "made in England"	102 Complete "Stock-Look" distributors available on page 47-50
13 Lobe sensor module	55 Ignitor version available in 6V negative ground, add N6 suffix	120 Except IGW-4181C
14 European models only	56 Ignitor version available in 6V positive ground, add P6 suffix	
20 Large cap distributor	57 Ignitor version available in 12V positive ground, add P12 suffix	
27 Screw down cap	63 With four lobe point cam	
28 Clip down cap	66 24-volt system	
32 Vacuum retard distributor	67 Mil-Spec Waterproof Ignition	
33 Vacuum advance distributor	71 Late DM2 distributor with one piece point set	
34 Non vacuum advance distributor	79 Not for use with solid core spark plug wires	

**NEW
NEW**

**NEW
NEW**

NEW

Description	Cyl	Rotation	Footnotes	Ignitor	Ignitor II	Ignitor III
BOSCH MANUFACTURED IN AUSTRALIA						
9230062653 (Motorcraft), 9230062663 (Holden)	6	CW	79	1865	91865	
9230063851 (Holden)	8	CW	79	1885	91885	
9230063856 (Motorcraft)	8	CCW	79	1886	91886	
CUSHMAN						
Scooter	1	CW	111	CU-111		
Truckster 18 & 22HP Engine	2	CCW	111, 112	CU-121		
DELCO						
1110224	6	CCW	56, 57, 79	2161	92161	
1111558	2	CW	51, 56, 57, 79	1121		
1111709, 1112571	2	CCW	52, 56, 57, 79	1123		
1111748	4	CW	55, 56, 57, 79	1142	91142	
1112457	3	CCW	79	1131		
1112576	2	CW	52, 56, 57, 79	1122		
1112589, 1112577	4	CCW	56, 57, 79	1143	91143	
D200, D202, D204	4	CCW	79	1149	91149	
1111702, 1110136	6	CW	13, 55, 56, 57, 79	1168LS	91168LS	
D200	6	CCW	13, 79	2163LS	92163LS	
DUCELLIER						
4155D, R251C34	4	CW	79	EP-141		
525294A	4	CCW	79	EP-142		
R275 E3A	4	CW	79	DU-141		
4290A	4	CW	13, 79	DU-142LS	9DU-142LS	
FORD / MOTORCRAFT						
C7NF 12127A	3	CCW	79	1231		
721F AHA 5JD, 71BB-AHB	4	CCW	79	1241LS	91241LS	
76HF DA 5CC	4	CCW	79	1249	91249	
35513	8	CCW	55, 56, 57, 79, 95	1285LS	91285LS	
78-12127, 11A-12127	8	CCW	55, 56, 57, 79, 86	1286LS	91286LS	
HITACHI						
D4B 880-01 (Mexico)	4	CCW	13, 79, 86	1742LSCC		
HOLLEY						
2562-1 69498	6	CW	79	HO-161A	9HO-161A	
285096-C91	8	CW	79, 83	HO-182	9HO-182	
INTERNATIONAL HARVESTER						
353898R1	4	CW	79	1442	91442	
368051R1	6	CCW	79	1461	91461	
LUCAS						
22D	6	CCW	57, 79	LU-166A	9LU-166A	
23D4	4	CCW	34, 57, 79	LU-148	9LU-148	
25D4	4	CCW	56, 57, 79, 102	LU-142A	9LU-142A	7LU-142A
23D6 & 25D6	6	CCW	57, 79	LU-162A	9LU-162A	
35D8	8	CW / CCW	33, 84, 79	LU-181A	9LU-181A	
35DE8, 35DM8 & 35DLM8	8	CW / CCW	2, 79	LU-288	9LU-288	
35DE8 (41383, 41608)	8	CW / CCW	2, 79	LU-188		
36DE12	12	CCW	2, 4, 79	LU-1122A	9LU-1122A	
36DM12	12	CCW	2, 4, 79	LU-1121A	9LU-1121A	
40068F	8	CCW	10, 33, 79	LU-186	9LU-186	
43D4	4	CCW	34, 79	LU-143A	9LU-143A	7LU-143A
45D4	4	CCW	33, 79, 102	LU-143A	9LU-143A	
43D6 / 45D6	6	CCW	45, 79	LU-163	9LU-163	
46D6 / 45D6	6	CCW	46, 79	LU-164	9LU-164	
45DE4, 45DM4, 47DE4, 47DM4	4	CCW	2, 79, 80	LU-147A	9LU-147A	
45DE6	6	CCW	2, 79	LU-161	9LU-161	
45DM6	6	CCW	2, 79	LU-167	9LU-167	
59D4	4	CCW	79	LU-143A	9LU-143A	7LU-143A
59D6	6	CCW	79	LU-263	9LU-263	
D3A4 40748A	4	CCW	24, 57, 79	LU-145	9LU-145	
DK4A, DKH4A, DKYH4A, DKY4A	4	CW / CCW	13, 56, 57, 79, 86	LU-146LS	9LU-146LS	
DM2 Early	4	CCW	13, 56, 57, 70, 79	LU-241LS	9LU-241LS	
DM2 Late	4	CCW	57, 71, 79	LU-149	9LU-149	
DM6, DM6A, DMBZ6A	6	CCW	57, 79	LU-165	9LU-165	
DVX6A, DVXH6A	6	CCW	13, 24, 57, 79	LU-168LS	9LU-168LS	
DX6A, DVXH6A	6	CW	13, 22, 57, 79	LU-169LS	9LU-169LS	

Description	Cyl	Rotation	Footnotes	Ignitor		
				Ignitor	Ignitor II	Ignitor III
MALLORY						
YL711A	3	CCW	34, 64, 79	ML-131A		
23, 24, YD, YL series distributors non vacuum	4	CW	56, 57, 79	ML-141C	9ML-141C	
23, 24, YD, YL series distributors non vacuum	4	CCW	56, 57, 79	ML-141CC	9ML-141CC	
23, 24, YD, YL series distributors non vacuum	6	CW / CCW	57, 79	ML-161	9ML-161	
25, 26, YD, YL series distributors non vacuum	8	CW / CCW	26, 56, 79, 91	ML-181	9ML-181	7ML-181
YL670 marine distributors	8	CW	79	ML-281	9ML-281	
27 Series	8	CW / CCW	10, 79	ML-186B	9ML-186B	7ML-186B
37, 38, 47, YLU Series Unilite	8	CW / CCW	79	ML-182	9ML-182	
YC Series (Rev-pol and Double Life)	8	CW / CCW	63, 79	ML-187	9ML-187	
YC, YCM Series	8	CW / CCW	10, 65, 79	ML-189	9ML-189	
Comp 9000 Series Unilite distributors	8	CW / CCW	79	ML-182	9ML-182	
MARELLI						
S76	2		79	MR-122		
S112, S134, S139, S144, S145, S146, S147	4	CW/CCW	13, 72, 79	MR-LS1	9MR-LS1	
S91, S96, S102, S103, S105, S106, S108	4	CW	13, 79	MR-LS2	9MR-LS2	
S118, S124B	4	CW	13, 79	MR-LS3	9MR-LS3	
S155, S156	4	CW	79	MR-142A	9MR-142A	
S73	4	CW	79	MR-143	9MR-143	
S77A, S83C	4	CW	79	MR-147	9MR-147	
S85A, S125A	6	CW	59, 64, 79, 85	MR-161A	9MR-161A	
S121A, S121B	6	CW	64, 79, 85	MR-162	9MR-162	
S53C	6	CW	10, 64, 79	MR-163	9MR-163	
S109A	6	CCW	10, 62, 79	MR-164	9MR-164	
S122AA	4	CW		MR-144	9MR-144	
S127C	8	CW	10, 63, 79, 85	MR-185	9MR-185	
S127E	8	CW	14, 59, 63, 79, 85	MR-184	9MR-184	
S127G	8	CW	14, 59, 63, 79, 85	MR-181A	9MR-181A	
S159A, S159AD, S159B	8	CW	60, 61, 63, 79, 85	MR-182A	9MR-182A	
S159A, S159AD, S159B	8	CW	63, 79, 85, 94	MR-183	9MR-183	
S138A	12	CW	60, 61, 62, 79, 85	MR-1121A	9MR-1121A	
S85A, S125	12	CW	60, 61, 64, 79, 85	MR-1122A	9MR-1122A	
S85B, C, CA	12	CCW	10, 24, 60, 61, 64, 79, 85	MR-1123	9MR-1123	
S129E	12	CCW	14, 59, 64, 79, 85	MR-1124	9MR-1124	
S129G	12	CCW	14, 24, 59, 64, 79, 85	MR-1125	9MR-1125	
MITSUBISHI						
TOT 00471	6	CCW	13, 86, 79	1762LS	91762LS	
TOT 00471, 22100 03510 (Nissan)	6	CCW	79	1762	91762	
T1T 12371	4	CW	79	1948	91948	
T2T 10496	4	CW	79	MA-141		
T3T 03571	4	CCW	79	1949	91949	
T3T 04582	4	CW	79	1942	91942	
T3T 05772	4	CW	79	1941	91941	
T3T 07192	4	CW	79	1947	91947	
T3T 07872	4	CW	79	1946	91946	
T3T 16171, T4T 11071	4	CCW	79	1943	91943	
T3T 61991	4	CW	79	1944	91944	
T4T 66871	4	CW	79	1945	91945	

FOOTNOTES

<p>2 Factory electronic ignition</p> <p>4 Non fuel injection models</p> <p>10 Dual point distributor</p> <p>13 Lobe sensor module</p> <p>14 European models only</p> <p>22 Clockwise rotation</p> <p>24 Counter clockwise rotation</p> <p>26 Excluding distributor number YL670AV</p> <p>33 Vacuum advance distributor</p> <p>34 Non vacuum advance distributor</p> <p>45 With red fixed points</p> <p>46 With blue sliding points</p> <p>51 Fires every 180 degrees</p> <p>52 Fires every 90 degrees</p>	<p>55 Ignitor version available in 6V negative ground, add N6 suffix</p> <p>56 Ignitor version available in 6V positive ground, add P6 suffix</p> <p>57 Ignitor version available in 12V positive ground, add P12 suffix</p> <p>59 Single distributor applications</p> <p>60 Dual distributor applications</p> <p>61 Kit contains one module for each distributor</p> <p>62 With six lobe point cam</p> <p>63 With four lobe point cam</p> <p>64 With three lobe point cam</p> <p>65 With eight lobe point cam</p> <p>70 Early DM2 distributor with two piece point set</p> <p>71 Late DM2 distributor with one piece point set</p> <p>72 Fit both single point and dual point distributors</p> <p>79 Not for use with solid core spark plug wires</p>	<p>80 Excluding distributor number 41812A</p> <p>83 With plastic sliding point plate</p> <p>84 Ignitor version available in 24v negative ground add N24 suffix</p> <p>85 Point cam felt bracket removal required</p> <p>86 Requires modification to distributor</p> <p>91 Excluding distributor numbers 2571501 & 2571601</p> <p>94 Enables one distributor to control timing and advance for both cylinder banks.</p> <p>95 2 bolt front mount distributor</p> <p>102 Complete "Stock-Look" distributors available on page 47-50</p> <p>111 For battery Ignition systems</p> <p>112 Timer with governor</p>
-----------------------------------------------------------------------------------------------------------------------------------------------------------------------------------------------------------------------------------------------------------------------------------------------------------------------------------------------------------------------------------------------------------------------------------------------------------------------------------------------------------	--------------------------------------------------------------------------------------------------------------------------------------------------------------------------------------------------------------------------------------------------------------------------------------------------------------------------------------------------------------------------------------------------------------------------------------------------------------------------------------------------------------------------------------------------------------------------------------------------------------------------------------------------------------------------------------------------------------------------------------------------------	------------------------------------------------------------------------------------------------------------------------------------------------------------------------------------------------------------------------------------------------------------------------------------------------------------------------------------------------------------------------------------------------------------------------------------------------------------------------------------------------------------------------------------------------------------------------------------------------------------------

Description	Cyl	Rotation	Footnotes	Ignitor	Ignitor II	Ignitor III
NIPPONDENSO						
19100-60061 029100-1231	6	CW	79	1661	91661	
19100-60062, 19100-60065 029100-2370	6	CW	79	1665A	91665A	
19100-87219 229100-7580	3	CCW	79	1631		
19100-61130 029100-6851	6	CW	79	1662	91662	
NEW 19100-61130 029100-6851	6	CW	13, 79	1662LS	91662LS	
229100-3130 (Denso), MD100991 (Mitsubishi)	4	CW	79	1645	91645	
33100-78410, 029100-7270	3	CW	79	1632		
WICO						
DB	4	CCW	24, 55, 56, 57, 79, 82	W0-141A	9W0-141A	



SERVICE PARTS

Ignitor and Ignitor II service parts are available separately. To order a module kit, add a "0" suffix to the original kit part number. For replacement magnet sleeves, add a "3" suffix to the original kit part number. Most module adapter plates are stamped with the kit part number.

EXAMPLE:	Part No.
Original Part Number:	1281
Replacement Module:	12810
Replacement Magnet Sleeve:	12813



REPLACEMENT ROTORS

Some Ignitor and Ignitor II kits are provided with a rotor to insure proper magnet sleeve engagement. The following kits have replacement rotors available:

Description	Part No.
1361A, 1381A, CH-161, CH-181 Rotor	1361AR
1581, 91581 Rotor	1581R

IGNITION POWER RELAY

Most pre-1974 vehicles are equipped with OE resistance wires which limit the current for breaker point operation. PerTronix's Ignitor II and Ignitor III ignition systems require a full 12V power connection between the ignition switch and the positive coil terminal. This requires bypassing the ballast resistor or resistance wire. In many cases, the original resistance wire is buried in the vehicle's wiring harness. Adding a PerTronix power relay will eliminate the need to dig through the wiring harness and replace wires. Plus, the power relay guarantees maximum system voltage for more power.

This 30 AMP relay kit can also be used with the original Ignitor conversion kits as well. The benefits in addition to easier installation are as follows:

FEATURES

- Easy to follow instructions make installation simple
- Minimizes conducted voltage spikes by isolating the ignition power source from other high current equipment
- Provides consistent full battery voltage... No more voltage fluctuations from overloaded ignition switches
- Eliminates problems from worn-out and corroded ignition switches, connectors and wires
- Universal design... Works with most battery ignition systems
- Small size... Keep your engine bay looking stock



<u>Description</u>	<u>Part No.</u>
Ignition Power Relay	2001

IGNITION PRIMARY WIRE EXTENSION KIT

Due to popular demand, we've made our 600V silicone jacketed wire available in kit form. This new primary wire extension kit can be used to increase the wire length on all Ignitor electronic conversion kits and distributors. Each kit includes 39" of our 20ga. ultra flexible wire. This wire features a silicone jacket rated at 300 degrees. All the necessary hardware is included for simple installation.



<u>Description</u>	<u>Part No.</u>
Ignition Primary Wire Extension Kit	2005

FOOTNOTES

- 13 Lobe sensor module
 24 Counter clockwise rotation
 55 Ignitor version available in 6V negative ground, add N6 suffix
 56 Ignitor version available in 6V positive ground, add P6 suffix
 57 Ignitor version available in 12V positive ground, add P12 suffix
 79 Not for use with solid core spark plug wires
 82 Will not fit magneto type distributors

APPLICATION NOTES

The following pages represent the most common Ignitor electronic conversions for marine applications. To assist in selecting the correct part number, use the following general guidelines:

- Read all footnotes before ordering
- Applications are based on the original equipment. For kits listed by distributor make and part number, turn to page 19
- Some kits use lobe sensor technology and do not use a magnet sleeve or ring
- Applications may have Ignitor, Ignitor II and or Ignitor III kits available. The part numbers for each version are found in there respective columns
- Refer to page 2 & 3 for a more detailed description and features of each version
- Unless otherwise noted, the part numbers in this catalog represent 12-volt negative ground kits. Many of our standard Ignitor applications are also available in 6-volt negative ground, as well as 6 and 12-volt positive ground. To order these special variations simply add a N6, P6 or P12 to the end of the part number when ordering. Ignitor II and Ignitor III kits are only available in 12-volt negative ground
- Compatible coils can be found in the coil section of this catalog
- As with all modern electronics, our modules must not be used with solid core spark plug wires. Suppression core spark plug wires can be found in the spark plug wire section of this catalog
- If your application can not be found in this catalog please visit www.pertronix.com or call us at (909) 547-9058 for updated application information

Year	Cyl	Model	Distributor Notes	Footnotes	Ignitor	Ignitor II	Ignitor III
ANTIQUE BOATS							
1949-62	4	Acadia - All models	Delco	55, 56, 57, 79	1142	91142	
1949-62	6	Acadia - All models	Delco	13, 55, 56, 57, 79	1168LS	91168LS	
1935-38	6	ACE Marine Model PC	Autolite	55, 79	1567A	91567A	
1974	4	Aeroceanic - All models	Autolite	55, 79	1548	91548	
1948-54	4	Aerojet - Crosley CD	Autolite IGW-4181A	56, 79, 110, 120	1545	91545	
1950-54	4	Aerojet - Crosley CD	Autolite IAD-4038	79	2541	92541	
1939-50	4	Arnolt - Sea-Mite	Autolite IGW-4118	56, 79, 120	1545	91545	
1946-47	4	Atlas - Her, IXB	Autolite IGW-4120, 92	56, 79, 120	1545	91545	
1938-40	6	Boat Engines Inc. - Hercules WXC3	Delco	13, 55, 56, 57, 79	1168LS	91168LS	
1947-53	4	Brennan - Imp, Imp Jr.	Autolite IGW-6003-2A	56, 79, 120	1545	91545	
1938-55	4	Buchanan - All models	Autolite IGW-Series	56, 79, 120	1545	91545	
1936-55	6	Buchanan - All models	Autolite IGW-Series	55, 56, 79	1568	91568	
1940-47	4	Buffalo Gas Motor - All models	Delco	55, 56, 57, 79	1142	91142	
1940-47	6	Buffalo Gas Motor - All models	Delco	13, 55, 56, 57, 79	1168LS	91168LS	
All	V12	Scripps Engines - All models	Delco SM-1562 & SM-1563	60, 61, 79	DE-1121		
CHEVROLET MARINE							
1980-88	V6	All models	Prestolite IBM-7021	79	1563B	91563B	
1985-92	V6	All models	Prestolite IDU-7602	2, 79	2562	92562	
1976-88	8	All models	Prestolite IBM-7011	28, 58, 79	1581	91581	71581
1976-88	8	All models	Prestolite IBM-7013	27, 58, 79	1582	91582	71581
CHRIS-CRAFT							
1975-80	4	FL181, FL153	Delco	22, 79	1146A	91146A	
1947-60	6	All models	Autolite IAY-4009	55, 56, 79	1564	91564	
1947-63	6	All models	Autolite IGC-4279A	55, 79	1567A	91567A	
1967-71	6	All models	Delco	55, 79	1164	91164	
1959-67	8	All models	Delco 1110630	10, 79	1183	91183	
1963-71	8	All models	Prestolite IBM-4115, 4116	28, 55, 58, 79	1581	91581	71581
1981-85	8	All models	Prestolite IBM-7013	27, 58, 79	1582	91582	71581
CHRYSLER INBOARD							
1967-71	6	155 (225 cu. in.)	Chrysler 2642513		1361A	91361A	
1959-72	8	M80, M81, M318A, B, C	Prestolite IBM-4106	28, 55, 58, 79	1581	91581	71581
1959-72	8	M413, D, M426X	Prestolite IBM-4106	28, 55, 58, 79	1581	91581	71581
1965-66	8	M318X	Prestolite IBM-4120	28, 55, 58, 79	1581	91581	71581
1983-88	8	273, 318, 340, 440 engine	Prestolite IBM-7016, 7017	27, 58, 79	1582	91582	71581
CRUSADER (THERMO-ELECTRON)							
1985-92	V6	All models	Prestolite IDU-7602	2, 79	2562	92562	
1961-69	8	283, 327, 409,	Prestolite IBM-4110	28, 55, 58, 79	1581	91581	71581
1961-69	8	185, 220, 230 HP	Mallory YL431A, YD431A	26, 56, 58, 79	ML-181	9ML-181	7ML-181
1961-71	8	283, 327, 409, 427 engine	Delco 1111161	79	1181	91181	71181
1975-78	8	302 cid. engine	Prestolite IBM-7007, A	28, 58, 79	1581	91581	71581
1977-82	8	305, 350, 454 cid. engine	Prestolite IBM-7011, C, D	28, 58, 79	1581	91581	71581
1983-87	8	305, 350, 454 cid. engine	Mallory	26, 58, 79	ML-181	9ML-181	7ML-181
1987-88	8	305, 350, 454 cid. engine	Prestolite IDU-7801	2, 79	1589	91589	

Year	Cyl	Model	Distributor Notes	Footnotes	Ignitor	Ignitor II	Ignitor III
DEARBORN MARINE							
1960-69	8	262, 272, 292, 312	Mallory YL350A, YL387A	26, 56, 58, 79	ML-181	9ML-181	7ML-181
1961-69	8	221, 260, 289, 352, 390	Mallory YL362, 455, 519	26, 58, 79	ML-181	9ML-181	7ML-181
1965-69	8	427	Mallory YL494A-2, B-2	26, 58, 79	ML-181	9ML-181	7ML-181
1966-69	8	260, 289, 302	Motorcraft	79	1281	91281	
FORD - (INTERCEPTOR)							
1973-88	8	302, 351, 460 cid. engine	Prestolite IBM-7007, 08	28, 58, 79	1581	91581	71581
1973-88	8	302, 351, 460 cid. engine	Prestolite IBM-7019, 20	27, 58, 79	1582	91582	71581
GREY MARINE							
NEW	1945-58	6 Phantom 6	Delco 1110515	79	2162	92162	
INDMAR PRODUCTS							
1979	8	All models	Prestolite IBM-7011	28, 79	1581	91581	71581
MARINE POWER SYSTEMS							
1978-83	8	305, 350, 454 cid. engine	Prestolite IBM-7011	28, 58, 79	1581	91581	71581
1978-83	8	305, 350, 454 cid. engine	Prestolite IBM-7013	27, 58, 79	1582	91582	71581
MERCUISER (MERCURY MARINE)							
All	4	110, 120, 140, 165, 170, 180, 190	Delco	22, 79	1146A	91146A	
All	4	470, 470R, 485, 488R	Delco	22, 79	1146A	91146A	
All	6	140, 150, 160, 165, 200	Delco	79	1163A	91163A	
All	6	Alpha 1 (120-140)	Delco	79	1163A	91163A	
All	8	190, 225	Delco	79	1181	91181	71181
All	8	233, 888	Prestolite	28, 79	1581	91581	71581
All	8	233	Prestolite	27, 79	1582	91582	71581
All	8	888	Mercruiser 64025, 64026	79	MC-181	9MC-181	
All	8	All	Mallory	8, 26, 79	ML-181	9ML-181	7ML-181
All	8	All	Mallory YL-670	79	ML-281		
OMC							
1964-88	4	100, 110, 120, 140 HP	Delco	22, 57, 79	1146A	91146A	
1982-88	4	2.5 Ltr., 3.0 Ltr.	Delco 982351	22, 79	1146A	91146A	
1964-66	6	150 HP	Delco 1110309, 1110322	79	1163A	91163A	
1967-72	6	155 HP	Delco 1110376	79	1164	91164	
1972-76	6	165 HP	Delco 980156	79	1163A	91163A	
All	V6	All models	Prestolite IDU-7602	2, 79	2562	92562	
1966-88	8	All V8 engines	Mallory	26, 58, 79	ML-181	9ML-181	
1974-88	8	All V8 engines	Prestolite 980902, 981080, 982320	28, 58, 79	1581	91581	71581
1982-88	8	All V8 engines	Prestolite IBM-7013C,D	27, 58, 79	1582	91582	71581
ONAN							
1961-80	4	MDJC	Autolite IGW-4409A	55, 56, 79	1545	91545	
PACEMAKER							
1965-70	8	Pacer 185, 190, 210, 220, 250, 320	Delco 1111161	19, 79	1181	91181	71181
1965-70	8	Charger	Delco 1111161	19, 79	1181	91181	71181
PLEASURECRAFT							
1975-78	8	Ford 302, 351, 460 cid. engine	Prestolite IBM-7007, IBM-7008	28, 58, 79	1581	91581	71581
1976-82	8	305, 350, 454 cid. engine	Prestolite IBM-7011	28, 58, 79	1581	91581	71581
1983-88	8	305, 350, 454 cid. engine	Prestolite IBM-7013	27, 58, 79	1582	91582	71581
SCRIPPS MARINE							
NEW	11944-52	4 F4	Delco 629P	79	2142	92142	
NEW	1944-48	6 All	Delco 1110515	79	2162	92162	
NEW	1944-52	6 F6	Delco 622W	79	2162	92162	
TELEDYNE MARINE CO. (GRAY MARINE)							
1950-69	6	F-6 Turbo	Mallory YL411C, D	57, 79	ML-161	9ML-161	
1950-69	8	138-178	Mallory YL429, C, D	26, 56, 58, 79	ML-181	9ML-181	7ML-181
1965-68	8	CF175, 195, CH175, 195	Prestolite IBM-4119, A	28, 58, 79	1581	91581	71581
All	8	401 cid. engine	Mallory YL455A, B; YL458B	26, 58, 79	ML-181	9ML-181	7ML-181
THERMO-ELECTRON							
1977-82	8	305, 350, 454 cid. engine	Prestolite IBM-7011D	28, 58, 79	1581	91581	71581
1981-82	8	305, 350, 454 cid. engine	Prestolite IBM-7013	27, 58, 79	1582	91582	71581
UNIVERSAL							
1961-68	4	Atomic, Super, Utility	Autolite IGW Series	56, 79	1545	91545	
1968-70	4	Atomic Four	Delco 1112446	22, 57, 79	1146A	91146A	
1961-68	6	Super Sabre V6	Delco 1110322	79	1164	91164	
1968-70	6	6 Cylinder	Mallory YL370B	57, 79	ML-161	9ML-161	
FOOTNOTES							

2 Factory electronic ignition
 8 Single point distributor
 10 Dual point distributor
 13 Lobe sensor module
 19 Mechanical advance at top of shaft
 22 Clockwise rotation
 26 Excluding distributor number YL670AV

27 Screw down cap
 28 Clip down cap
 55 Ignitor version available in 6V negative ground, add N6 suffix
 56 Ignitor version available in 6V positive ground, add P6 suffix
 57 Ignitor version available in 12V positive ground, add P12 suffix
 58 OMC; Stringer, Cobra and King Cobra applications with Electronic Shift Assist may require slight wiring modification.

60 Dual distributor applications
 61 Kit contains one module for each distributor
 79 Not for use with solid core spark plug wires
 110 Excluding distributor number IGW-4181C
 120 Except IGW-4181C

Year	Cyl	Model	Distributor Notes	Footnotes	Ignitor	Ignitor II	Ignitor III
VOLVO-PENTA							
All	4	All models	Bosch 231178017	79	2842	92842	
All	V6	All models	Prestolite IDU-7602	2, 79	2562	92562	
1977-82	8	All models	Prestolite IBM-7011A	28, 58, 79	1581	91581	71581
1977-82	8	All models	Prestolite IBM-7013A	27, 58, 79	1582	91582	71581
1986-88	8	All models	Prestolite IDU-7801	2, 79	1589	91589	
WAUKESHA							
1959-73	4	IC, FC, FCS, FS (12 Volt)	Autolite IGW-4301-3	56, 79	1545	91545	
1975-78	4	VGR-155	Delco 1112470	22, 57, 79	1146A	91146A	
WISCONSIN							
1948-57	4	VE4, VF4, VL4, VP4 (12 Volt)	Autolite IGW-Series	56, 79	1545	91545	
1953-57	4	VG4, VR4	Prestolite IAD-6004-2F	55, 56, 57, 79	1541	91541	
1957-85	4	V460D, VE-4, VF-4	Prestolite IAD-6004-2F, 2N	55, 56, 57, 79	1541	91541	
1957-85	4	VG4D, VP-4D, VH4, DM VR4D	Prestolite IAD-6004-2F, 2N	55, 56, 57, 79	1541	91541	

MARINE APPLICATION BY DISTRIBUTOR NUMBER

Distributor Notes	Cyl	Footnotes	Ignitor	Ignitor II	Ignitor III
AUTOLITE / PRESTOLITE					
IAD-4038	4	79	2541	92541	
IAD-6004-2F, 2N	4	55, 56, 57, 79	1541	91541	
IAY-4009	6	55, 56, 79	1564	91564	
IBM-4106, 4110	8	28, 55, 58, 79	1581	91581	71581
IBM-4115, 4116	8	28, 55, 58, 79	1581	91581	71581
IBM-4119, 4120	8	28, 58, 79	1581	91581	71581
IBM-7007, 7008	8	28, 58, 79	1581	91581	71581
IBM-7011	8	28, 58, 79	1581	91581	71581
IBM-7013, 7016, 7017	8	27, 58, 79	1582	91582	71581
IBM-7019, 7020	8	27, 58, 79	1582	91582	71581
IBM-7021	6	79	1563B	91563B	
IBM-7026	4	79	1546	91546	
IDU-7602	6	2, 79	2562	92562	
IDU-7801	8	2, 79	1589	91589	
IGC-4279A	6	55, 79	1567A	91567A	
IGW Series	4	55, 56, 79	1545	91545	
IGW Series	6	55, 56, 79	1568	91568	
BOSCH					
231178017	4	79	2842	92842	
CHRYSLER					
2642513	6	79	1361A	91361A	
DELCO					
1110630	8	10, 79	1183	91183	
1111161	8	19, 79	1181	91181	71181
1111748	4	55, 56, 57, 79	1142	91142	
1112457	3	79	1131		
1112576	2	52, 56, 57, 79	1122		
1110309, 1110322	6	79	1163A	91163A	
1110322, 1110376	6	79	1164	91164	
1112446, 1112470	4	22, 57, 79	1146A	91146A	
1112589, 1112577	4	56, 57, 79	1143	91143	
SM-1562 & SM-1563	12	60, 61, 79	DE-1121		
MALLORY					
Mallory YL Series	8	26, 56, 58, 79	ML-181	9ML-181	7ML-181
Mallory YL670	8	58, 79	ML-281		
Mallory YL370B	6	57, 79	ML-161	9ML-161	
Mallory YL411C, D	6	57, 79	ML-161	9ML-161	
MERCUISER					
64025, 64026	8	79	MC-181	9MC-181	

APPLICATION NOTES

The following pages represent the most common Ignitor electronic conversions for industrial applications. To assist in selecting the correct part number, use the following general guidelines:

- Read all footnotes before ordering
- Applications are based on the original equipment. For kits listed by distributor make and part number, turn to page 19
- Some kits use Lobe Sensor Modules, which senses the point cam and do not use a magnet sleeve or ring
- Applications may have Ignitor or Ignitor II kits available. The part numbers for each version are found in their respective columns. Refer to page 2 & 3 for an extended description of features and a comparison chart
- Unless otherwise noted, the part numbers in this catalog represent 12-volt negative ground kits. Many of our standard Ignitor applications are also available in 6-volt negative ground, as well as 6 and 12-volt positive ground. To order these special variations simply add a N6, P6 or P12 to the end of the part number when ordering. Ignitor II kits are only available in 12-volt negative ground
- Compatible coils can be found in the coil section of this catalog
- As with all modern electronics, our modules must not be used with solid core spark plug wires. Suppression core spark plug wires can be found in the spark plug wire section of this catalog
- If your application can not be found in this catalog please visit www.pertronix.com or call us at (909) 547-9058 for updated application information

Year	Cyl	Model	Distributor Notes	Footnotes	Ignitor	Ignitor II
ALLIS CHALMERS						
1957-58	4	4B-153, 4B-182	AutoLite IAD-6003-1A	55, 56, 57, 79	1541	91541
1965-68	4	H4 Crawler Tractor	Delco 1112665	24, 55, 57, 79	1145A	91145A
1969-72	4	FP-20, 30; FT20, 25; FTB30-24	Delco 1112455	24, 55, 57, 79	1145A	91145A
1969-72	4	FP-20, 30; FT20, 25; FTB30-24	Delco 1112486	22, 79	1146A	91146A
1969-72	4	F30, 40, 50; FP40, 50	Delco 1112460	22, 79	1146A	91146A
1971-74	4	G138, 160, 226	Delco 1112688	22, 79	1146A	91146A
1972	4	Model 600	Delco 1112490	24, 55, 57, 79	1145A	91145A
1973	4	AC-C20, 25, 30, 35, 40, 45, 50, 55;	Delco 1112490	24, 55, 57, 79	1145A	91145A
1973	4	AC-P20, 25, 30; FP-40, 55; Model 500	Delco 1112490	24, 55, 57, 79	1145A	91145A
1973	4	AC-C20, 25, 30, 35, 40, 45, 50, 55; AC-P20, 25, 30	Delco 1112460, 86	22, 79	6A	91146A
1973	4	FP-40, 55; Model 500	Delco 1112460, 86	22, 79	1146A	91146A
1974	4	AC-C35, 40, 45, 50, 55; AC-P40, 50	Delco 1112460	22, 79	1146A	91146A
1975-82	4	Continental F163 engines	Prestolite IBT-4701C	55, 57, 79	1542	91542
1976-82	4	Continental F163 engines	Prestolite IDJ-4008	2, 21, 79	2542	92542
1957-58	6	6B-230, 6B-273	Prestolite IAD-6001-1B	56, 57, 79	1561	91561
1967-69	6	TL545 Tractor Loader	Delco 1112668, 1111311	56, 57, 79	1163A	91163A
1969-73	6	F60, 70, 80, 100, 120, FP60, 70, 80	Delco 1112461	56, 57, 79	1163A	91163A
1969-74	6	G262	Delco 1112461	56, 57, 79	1163A	91163A
1973-74	6	All AC-C, AC-P Series	Delco 1112461	56, 57, 79	1163A	91163A
1975-82	6	All Continental F Series	Prestolite IBT-6705, 01D	55, 57, 79	1562	91562
AUTOCAR						
1947-53	6	All models	AutoLite IAD Series	56, 57, 79	1561	91561
BAKER						
1961-66	4	Hercules IXLB engines	Prestolite IAD-6003B	55, 56, 57, 79	1541	91541
1963-82	4	Continental F163 engines	Prestolite IBT-4701	55, 57, 79	1542	91542
1960-62	6	Type Me-1A Towing Tractor with Chrysler engine	Prestolite IAD-4039-1	56, 57, 79	1561	91561
1972-81	6	Continental F226, F245 engines	Prestolite IBT-6701D	55, 57, 79	1562	91562
BAY CITY (CRANE)						
All	6	15, 15A; 25, 30, 37, 45, T50, T150, T180, T185, T450	Prestolite IAD, IGC Series	56, 57, 79	1561	91561

FOOTNOTES

<p>2 Factory electronic ignition</p> <p>10 Dual point distributor</p> <p>19 Mechanical advance at top of shaft</p> <p>21 See page 56 for complete replacement distributors</p> <p>22 Clockwise rotation</p> <p>24 Counter clockwise rotation</p> <p>26 Excluding distributor number YL670AV</p> <p>27 Screw down cap</p> <p>28 Clip down cap</p> <p>52 Fires every 90 degrees</p> <p>55 Ignitor version available in 6V negative ground, add N6 suffix</p>	<p>56 Ignitor version available in 6V positive ground, add P6 suffix</p> <p>57 Ignitor version available in 12V positive ground, add P12 suffix</p> <p>58 OMC; Stringer, Cobra and King Cobra applications with Electronic Shift Assist may require slight wiring modification.</p> <p>60 Dual distributor applications</p> <p>61 Kit contains one module for each distributor</p> <p>79 Not for use with solid core spark plug wires</p>
------------------------------------------------------------------------------------------------------------------------------------------------------------------------------------------------------------------------------------------------------------------------------------------------------------------------------------------------------------------------------------------------------------------------------------------------------------	-------------------------------------------------------------------------------------------------------------------------------------------------------------------------------------------------------------------------------------------------------------------------------------------------------------------------------------------------------------------------------------------------------------------------------------------



Year	Cyl	Model	Distributor Notes	Footnotes	Ignitor	Ignitor II
BROCKWAY						
1937-42	6	All models	AutoLite IGC Series	79	1567A	91567A
1952-66	6	All models	Delco	27, 34, 56, 57, 79	1163A	91163A
1950-71	6	All models	Prestolite IAD, IGC Series	56, 57, 79	1561	91561
BUDA						
1951-56	4	FB	AutoLite IGW-4118A	55, 56, 79	1545	91545
1951-72	4	4B-153, 182	Prestolite IAD-6003-1A	55, 56, 57, 79	1541	91541
1952-53	4	FT-30, 40, 50, 60, TG	AutoLite IAD-6003-1A	55, 56, 57, 79	1541	91541
1950-72	6	6B-190, 205, 221, 225, 230	Prestolite IAD-6001-1B	56, 57, 79	1561	91561
1950-73	6	K-325, 369, 393, 428; L-468, 525; Lo-525	Prestolite IGC-6001	56, 57, 79	1561	91561
1950-73	6	H-260, 298; HP-260, 298, 326, 351	Prestolite IGC-6001	56, 57, 79	1561	91561
1953-54	6	FT-60, 75; HA, HB, JG	Auto/Prestolite IAD-6001-1B	56, 57, 79	1561	91561
CASE						
All	4	148 gas engine	Prestolite IAD-6003-2K	55, 56, 57, 79	1541	91541
All	4	Utility 435-LCK, (Own G188); 480CK	Prestolite IAD-6003-2J	55, 56, 57, 79	1541	91541
All	4	Lift Truck 580CK, (Own G159); Utility 500, 535, CLK	Prestolite IAD-6003-2F	55, 56, 57, 79	1541	91541
All	4	P-50 Hydra Place (Own G188)	Prestolite IAD-6003-2F	55, 56, 57, 79	1541	91541
All	4	SK1D (Gas, LPG)	Prestolite IAD-6003-1B	55, 56, 57, 79	1541	91541
All	4	319 Power Unit	Prestolite IAD-6003-2J	55, 56, 57, 79	1541	91541
All	4	Lift Trucks (Own VA 339)	Prestolite IAD-6003-2F	55, 56, 57, 79	1541	91541
All	4	W5AG (188 engine); 480CK, 580CK, (G-148, 159)	Prestolite IBT-4403A	55, 57, 79	1542	91542
All	4	Utility 680CK, (Own A267)	Prestolite IBT-4404, A	79	1542	91542
All	4	A-267; A-284G Power Unit, (Own A284)	Prestolite IBT-4404, A	79	1542	91542
All	4	5400C Airport Tractor	Prestolite IBT-4402A	55, 57, 79	1542	91542
All	4	W7, W9AG Loaders (A284 engine)	Prestolite IBT-4402	55, 57, 79	1542	91542
All	4	1737S loader	Prestolite IDD-4104	2, 79	2542	92542
All	4	1830 Skid Steer	Duceller	79	EP-141	
CATERPILLAR						
1976-80	4	Industrial engine	Prestolite IBT-4701	55, 57, 79	1542	91542
1980-82	4	Lift Truck	Prestolite IDJ-4005	79	2542	92542
1977	6	Industrial engine	Prestolite IBT-6702	21, 55, 57, 79	1562	91562
1979	6	Lift Truck	Prestolite IDJ-4014	21, 55, 57, 79	1562	91562
1979-80	8	Lift Truck (IHC-V345 engine)	Prestolite IDN-4102B	79	1485A	91485A
CHEVROLET						
1963-65	4	153 cid. engine with vacuum advance distributor	Delco	29, 79	1144A	91144A
1963-75	6	194, 230, 250, 292	Delco	8, 79	1162A	91162A
1956-76	8	All models	Delco	19, 79	1181	91181
1956-76	8	All models	Delco	13, 19, 79	1181LS	91181LS
CHICAGO PNEUMATIC TOOL CO.						
1955-63	4	75PG-20	Prestolite IAD-6003B	55, 56, 57, 79	1541	91541
1955-72	4	125RG-2	Prestolite IAD-4037	55, 56, 57, 79	1541	91541
1958-71	4	125RG-1; 125RG-2 (Hercules G-2000 engine)	Prestolite IAD-4043	55, 56, 57, 79	1541	91541
1959-73	4	85RG-2 (Continental F162 engine)	Prestolite IAD-6004-1C	55, 56, 57, 79	1541	91541
1961-73	4	85RJ-1	Prestolite IBT-4705	21, 55, 57, 79	1542	91542
1955-65	6	210RG-2	Prestolite IAD-6001E	56, 57, 79	1561	91561
1961-73	6	85RJ-1	Prestolite IAD-6001E	56, 57, 79	1561	91561
CHRYSLER						
All	6	5A, 6A, 7A, 8A, 13, 13A, 14A, 15A, 16A, 22A	Prestolite IAD, IAO Series	56, 57, 79	1561	91561
All	6	32, 33, 908A, 931	Prestolite IAD, IAO Series	56, 57, 79	1561	91561
All	6	5A, 6A	Prestolite IAT Series	55, 57, 79	1562	91562
All	6	H-170; H-225, 236, 251, 265, 313	Prestolite IBR-4202	55, 57, 79	1562	91562
All	6	H-225	Chrysler	8, 79	1361A	91361A
All	8	H, HB, HT-318, HT-361, 413, 475, 476	Chrysler	8, 79	1381A	91381A
All	8	M273, ML318, ML340	Prestolite IBM-7004B	79	1581	91581
CLARK						
1964-65	4	C-20, 20P, 20SU, 25, 25SU, 30, 40	Delco 1112637	21, 24, 55, 57, 79	1145A	91145A
1964-65	4	CF-20, 25; CY-20, 30	Delco 1112637	21, 24, 55, 57, 79	1145A	91145A
1966	4	C-20 - 50; CF-20, 30, 40, 50; Clarkette, Towtractor	Delco 1112673	21, 24, 55, 57, 79	1145A	91145A
1967-70	4	C-20, 20SU, 30B, 40B, 50B; CF-20, 30B, 40B, 50B	Delco 1112673	21, 24, 55, 57, 79	1145A	91145A
1967-70	4	CY-20, 25, 30B, 40B, 50B	Delco 1112673	21, 24, 55, 57, 79	1145A	91145A
1967-78	4	C-500-30, 35, 40, 45, 50, 55;	Delco 1112685	21, 22, 57, 79	1146A	91146A
1967-78	4	C-500H-40, 45, 55; Y-40, 45, 50, 55	Delco 1112685	21, 22, 57, 79	1146A	91146A
1969-71	4	Clarkette; IT-30, 40	Delco 1112673	21, 24, 55, 57, 79	1145A	91145A
1971	4	C-20, 25; CF-20, 25; CY-20; CFY-20	Delco 1112673	21, 24, 55, 57, 79	1145A	91145A
1972-78	4	C500-20, 20P, 25, 25P; C-500F-20P, 25P	Prestolite IBT-4105	2, 21, 55, 57, 79	1542	91542
1972-78	4	C-500Y-20, 25, 30	Prestolite IBT-4105	2, 21, 55, 57, 79	1542	91542

Year	Cyl	Model	Distributor Notes	Footnotes	Ignitor	Ignitor II
CLARK (CONTINUED)						
1972-78	4	C-500YF-20, 25, 30; IT-40B, Clarkat	Prestolite IBT-4105	2, 21, 55, 57, 79	1542	91542
1972-78	4	C500-20, 20P, 25, 25P; C-500F-20P, 25P	Delco 1112673	21, 24, 55, 57, 79	1145A	91145A
1972-78	4	C-500Y-20, 25, 30	Delco 1112673	21, 24, 55, 57, 79	1145A	91145A
1972-78	4	C-500YF-20, 25, 30; IT-40B, Clarkat	Delco 1112673	21, 24, 55, 57, 79	1145A	91145A
1975-78	4	C500-30, 35, 40, 45, 50, 55; C-500H-40, 45, 50, 55	Delco 1111700	21, 22, 57, 79	1146A	91146A
1975-78	4	Y-40, 45, 50, 55	Delco 1111700	21, 22, 57, 79	1146A	91146A
1977-78	4	Clarkat; IT40B	Delco 1112673	21, 24, 55, 57, 79	1145A	91145A
1977-83	4	All models	Prestolite IBT-4706	21, 55, 57, 79	1542	91542
1982	4	D176 (Waukesha engine)	Prestolite IDU-4403	2, 21, 79	2542	92542
1982	4	F163 TCM engine	Prestolite IDU-4404	2, 79	2542	92542
1982-84	4	Lift Truck	Prestolite IDU-4003, 04	2, 79	2542	92542
1956-66	6	All models	Prestolite IAD-6001D	56, 57, 79	1561	91561
1964-65	6	C-60; CY-60; CFY-60	Delco 1112628	21, 56, 57, 79	1163A	91163A
1966	6	CT-20, 30, 40, 50; UT- 60, 70, 80, 100	Delco 1112672	21, 56, 57, 79	1163A	91163A
1966	6	HUT-60, 70, 80, 100; Y60, 100	Delco 1112672	21, 56, 57, 79	1163A	91163A
1966-70	6	C & CF 60, 70, 80; CH-60, 70, 80 CY-60, 70, 80	Delco 1112672	21, 56, 57, 79	1163A	91163A
1966-71	6	C-100, 120; CY-100, 120; Ranger 40, 60	Delco 1112672	21, 56, 57, 79	1163A	91163A
1967-69	6	IT-60	Delco 1112672	21, 56, 57, 79	1163A	91163A
1972-78	6	C-500H-60, 70, 80; C500-100, 200	Delco 1112672	21, 56, 57, 79	1163A	91163A
1972-78	6	C-500Y-100, 130, 150; Ranger 40, 60	Delco 1112672	21, 56, 57, 79	1163A	91163A
1977-83	6	All models	Prestolite IBT-6703	21, 55, 57, 79	1562	91562
1982	6	F227 TCM engine	Prestolite IDU-4602	55, 57, 79	1562	91562
CLIMAX						
All	4	FM1, 3 engine	AutoLite IGW-4120	56, 79	1545	91545
All	4	(Hercules NX engine)	AutoLite IGW-4122	56, 79	1545	91545
All	4	(Waukesha ICK engine)	AutoLite IGW-4118	56, 79	1545	91545
CONTINENTAL						
All	4	F4, G, H, J, N, Y engines	Prestolite IAD Series	21, 55, 56, 57, 79	1541	91541
All	4	F-163 engine	Prestolite IDJ-4008	2, 79	2542	92542
All	4	F4 engine	Auto/Prestolite IBT-4501,701	55, 57, 79	1542	91542
All	4	F4 and Y engines	AutoLite IGW Series	21, 55, 56, 79	1545	91545
All	4	F4 engine	Delco	21, 24, 55, 57, 79	1145A	91145A
1961-66	6	M Series	Prestolite IBT-6401B	24, 79	1565	91565
1961-67	6	B Series	Prestolite IBT-6401C	24, 79	1565	91565
1961-71	6	F Series	Prestolite IBT-6401A	24, 79	1565	91565
All	6	B, E, M engines	AutoLite IAD-6002	21, 56, 57, 79	1561	91561
All	6	F6 engine	Delco	21, 56, 57, 79	1163A	91163A
All	6	F6, K, R, S, T, U engines	AutoLite IAD Series	56, 57, 79	1561	91561
All	6	F6, M engines	Prestolite IBT-6501, 701, 702	21, 55, 57, 79	1562	91562
CROSLEY						
All	4	Own CD	AutoLite IAD-4038	55, 56, 57, 79	1541	91541
All	4	Own CD engine	AutoLite IGW	55, 56, 79, 110	1545	91545
DATSUN / NISSAN						
All	4	D-11, H-20	Hitachi	79	1741	91741
All	4	H-20	Mitsubishi	79	1943	91943
All	6	H-30, P-40	Hitachi	79	1761	91761
DODGE						
1961-73	6	All models	Chrysler	8, 79	1361A	91361A
1973-81	6	All models	Chrysler	2, 15, 79	CH-161	9CH-161
1959-71	8	383, 413, 426, 440 cid. (Hemi Included)	Chrysler	10, 79	1385	91385
1962-73	8	All models	Chrysler	8, 79	1381A	91381A
1969-73	8	All models	Holley	79	1481	91481
1973-81	8	All models	Chrysler	2, 15, 79	CH-181	9CH-181
1974-83	8	404, 446 cid.	Prestolite	2, 33, 79	1484A	91484A
DUPLEX						
All	6	Shovel Chassis, Wagon Crane, (B-6427, F6244)	AutoLite IAD-6002-1F	21, 56, 57, 79	1561	91561

FOOTNOTES

2	Factory electronic ignition	33	Vacuum advance distributor
8	Single point distributor	34	Non vacuum advance distributor
10	Dual point distributor	55	Ignitor version available in 6V negative ground, add N6 suffix
13	Lobe sensor module	56	Ignitor version available in 6V positive ground, add P6 suffix
15	Excluding lean burn computer controlled engines	57	Ignitor version available in 12V positive ground, add P12 suffix
19	Mechanical advance at top of shaft	79	Not for use with solid core spark plug wires
21	See page 56 for complete replacement distributors	110	Excluding distributor number IGW-4181C
22	Clockwise rotation		
24	Counter clockwise rotation		
27	Screw down cap		
29	Excluding distributor number IAD-4036		

Year	Cyl	Model	Distributor Notes	Footnotes	Ignitor	Ignitor II
DYNA-TRUCK						
1971	6	Dyna Mite 6-232, 258	Delco	79	1162A	91162A
EARTH MASTER						
All	4	C, CH, CN, CNH, D, DH	AutoLite IAD-6003-2A	55, 56, 57, 79	1541	91541
EARTHMOVING EQUIPMENT						
1967-69	8	All models	Delco 1112744	79	1181	91181
EATON, YALE, TOWNE						
1955-62	4	F-162 Continental engine	Prestolite IAD-6004-1D	55, 56, 57, 79	1541	91541
1963	4	All models	Prestolite IAD-4043	55, 56, 57, 79	1541	91541
1965-66	4	GLF, GLFP, GLFW, GLT	Delco 1112637	21, 24, 55, 57, 79	1145A	91145A
1968-75	4	JX4D Hercules engine	Prestolite IAD-4037	55, 56, 57, 79	1541	91541
1973-81	4	Mazda engine	Prestolite IDJ-4010	2, 79	2542	92542
1975-82	4	GC, GP 20-30 (Mazda engine)	Mazda 9022313-00	79	MA-141	
1976-77	4	F-163 Continental engine	Prestolite IDJ-4008	2, 79	2542	92542
1976-79	4	Ford engine	Prestolite IDJ-4006	2, 79	2542	92542
All	4	F-124 Continental engine	Prestolite IAD Series	55, 56, 57, 79	1541	91541
1955-60	6	All models	Prestolite IAD-4039-1	56, 57, 79	1561	91561
1969	6	Lift Truck	Prestolite IBD-4009UT	55, 57, 79	1562	91562
1977-79	6	225 Chrysler engine	Prestolite IDJ-4011	55, 57, 79	1562	91562
All	6	Chrysler engine	Prestolite IAD-4039-1	56, 57, 79	1561	91561
ELGIN SWEEPER						
1963-69	8	H Street King	Delco 1112744	79	1181	91181
1965-70	8	Pelican, White Wing, Fleet Wing	Delco 1112744	79	1181	91181
ERICKSON						
All	4	Loader HL3030, LC4D-G	Prestolite IAD-6004-2N	21, 55, 56, 57, 79	1541	91541
All	4	61, 200	Prestolite IAD-6004-2F	21, 55, 56, 57, 79	1541	91541
FAGEOL PRODUCTS						
All	4	Crosley engine	AutoLite IGW-4181,401	55, 56, 79, 110, 120	1545	91545
FAIRMONT RAILWAY PRODUCTS						
All	4	A5, A7A Gang Car	AutoLite IGW-4118A	55, 56, 79, 120	1545	91545
All	4	Waukesha, ICK; (Hercules ZXB engine)	AutoLite IGW-4301	55, 56, 79, 120	1545	91545
FATE ROOT HEATH (SILVER KING)						
All	4	440 (1XB-3 engine)	AutoLite IGW-4120-1	55, 56, 79, 120	1545	91545
FORD						
All	4	172 & 192 engine	FoMoCo 311185	55, 56, 57, 79	1244A	91244A
1984	6	300 engine	FoMoCo E4JE-12127-BA	79	1263	91263
1963-67	6	All models (excluding V-6 engine)	Ford	55, 68, 79	1266	91266
1949-74	6	All models (excluding V-6 engine)	Motorcraft	69, 79	1261	91261
1975-77	6	300 cid. engine	FoMoCo D5TE-12127VA	79	1262	91262
1968-84	6	200 engine	FoMoCo D3JF-12127-BA	69, 79	1261	91261
1986	8	460 engine	FoMoCo E3TZ-12127-BAA	2, 20, 79	FO-182	9FO-182
1974-76	8	All models	FoMoCo	2, 17, 79	FO-181	9FO-181
1958-78	8	All models (excluding '58 & '59 272 engine)	FoMoCo	79	1281	91281
1976-79	8	534 engine	FoMoCo D6HZ-12127-E	2, 17, 79	FO-181	9FO-181
1977-83	8	All models	FoMoCo	2, 20, 79	FO-182	9FO-182
FRIGIDKING						
1965	4	Waukesha 1CK engine	AutoLite IAD-6004A	55, 56, 57, 79	1541	91541
GALION IRON WORKS						
All	4	3-5 Ton Roller	AutoLite IGW-4159A	55, 56, 79, 120	1545	91545
All	6	5-8 Ton Roller	AutoLite IAD-6002-1F	21, 56, 57, 79	1561	91561
GAMBLES FARMCREST						
All	4	20, 30	AutoLite IAD-6002,03, 04	55, 56, 57, 79	1541	91541
All	6	40	AutoLite IAD-6001-1B	56, 57, 79	1561	91561
GMC						
1963-66	4	153 cid. engine	Delco	79	1144A	91144A
1960-64	6	305-C, 351, 401, 478 cid. V6 engine	Delco	79	1164	91164
1963-64	6	All models (excluding 305-C, 351, 401, 478 cid. V6)	Delco	79	1162A	91162A
1965-74	6	V6 engine	Delco	79	1162A	91162A
1958-76	8	All models	Delco	19, 79	1181	91181
1958-76	8	All models	Delco	13, 19, 79	1181LS	91181LS
HARRIS						
All	6	PH-43, PH-53 (5A, 8A engine)	Prestolite IAD-4039, 40	56, 57, 79	1561	91561
All	6	SPH-88, F6WC, F8, F8WC	Prestolite IAD Series	56, 57, 79	1561	91561

Year	Cyl	Model	Distributor Notes	Footnotes	Ignitor	Ignitor II
HERCULES ENGINE						
All	4	G1400, 1600 (gas engine)	Prestolite IAD-6013	55, 56, 57, 79	1541	91541
All	4	G, GO, IX, IXB, JX, ZX, ZXA, ZXB, CU4-180, 00	Prestolite IAD Series	55, 56, 57, 79	1541	91541
All	4	IX, ZX Series	AutoLite IGW Series	55, 56, 79	1545	91545
All	4	G1600	Prestolite IBT-4405	55, 57, 79	1542	91542
NEW All	6	G3400	Prestolite IDU-4605	2, 22, 79	2564	
HI-DYNAMIC						
All	4	P-40 Platform Truck	AutoLite IAD-6004-2A	55, 56, 57, 79	1541	91541
All	4	HA (Waukesha FC engine)	AutoLite IGW-4301	55, 56, 79	1545	91545
1971-72	6	250C Crane	Delco 1112682	79	1163A	91163A
All	6	HF-HM (4WD Shovel), HMG, HR, HV	Prestolite IAD-6001	56, 57, 79	1561	91561
HYSTER						
1965-66	4	Lift Truck	Delco	21, 24, 55, 57, 79	1145A	91145A
1967-69	4	Challenger H40F, 50F	Delco 1112443	21, 24, 55, 57, 79	1145A	91145A
1967-69	4	Spacesaver S-30B, 40B, 50B	Delco 1112635	24, 55, 57, 79	1145A	91145A
1967-69	4	Spacesaver S-40C, 50C	Delco 1112677	24, 55, 57, 79	1145A	91145A
1967-69	4	Spacesaver S-30B, 40B, 50B	Delco 1112627	22, 79	1146A	91146A
1972-78	4	Challenger H-20, 25, 30, 60, 70	Delco	21, 24, 55, 57, 79	1145A	91145A
1972-78	4	Spacesaver S-20, 25, 30, 40, 50	Delco	21, 24, 55, 57, 79	1145A	91145A
1978-79	4	Misc. models	Prestolite IBT-4705	21, 55, 57, 79	1542	91542
1979-83	4	Misc. models	Prestolite IBT-4707	55, 57, 79	1542	91542
All	4	450XL	Mazda 326835	79	MA-141	
1962	6	Challenger H250A Lift Truck	Delco 1110262	79	1164	91164
1963-66	6	Straddle Truck & Lift Truck	Delco 1110262	79	1164	91164
1965-66	6	Straddle Truck & Lift Truck	Delco 1110317	56, 57, 79	1163A	91163A
1967-78	6	Lift Truck	Delco	21, 56, 57, 79	1163A	91163A
1978-79	6	Misc. models	Prestolite IBT-6702	21, 55, 57, 79	1562	91562
1979-83	6	Misc. models	Prestolite IBT-6704	55, 57, 79	1562	91562
IHC TRUCK						
1967-70	6	220, 241, 265, 282, 308 cid. engine	Delco	56, 57, 79	1162A	91162A
1969-71	6	406, 450, 501 cid. engine	Delco	8, 56, 57, 79	1162A	91162A
1971-74	6	258 cid. engine	Delco	56, 57, 79	1162A	91162A
1959-64	8	266, 304, 345 cid. engine	Delco	79	1181	91181
1964-70	8	478, 549 cid. engine	Holley	22, 79	1481	91481
1964-70	8	478, 549 cid. engine	Holley	24, 79	1482	91482
1964-83	8	266, 304, 345, 392 cid. engines	Prestolite	33, 79	1483A	91483A
1964-83	8	266, 304, 345, 392 cid. engines	Prestolite	34, 79	1485A	91485A
1968-71	8	266, 304 cid. engine	Holley	79	1481	91481
1971-78	8	All models	Holley	79	1481	91481
1974	8	400 cid. engine	Delco	19, 79	1181	91181
1974-83	8	304, 345, 392 cid. engine	Prestolite	34, 79	1485A	91485A
J.A. FREEMAN						
1959-73	4	25A, 25AW, 25ACWT, 26, 28; 100T, 100W	Prestolite IAD-6004	21, 55, 56, 57, 79	1541	91541
1959-73	4	200T, 200W, 300T, 300W, 330W	Prestolite IAD-6004	21, 55, 56, 57, 79	1541	91541
JAEGER						
All	4	60 Compressor	AutoLite IGW-4156D	55, 56, 79	1545	91545
All	4	75, 85 Compressors; 2HM Mixer	Prestolite IAD Series	29, 79	1542	91542
All	6	105, 125, 125A, B, 150, 160, 185, 250 "Air Plus"	Prestolite IAD Series	29, 56, 57, 79	1561	91561
All	6	315, 3HM, 4 1/2 HM Mixers	Prestolite IAD Series	29, 56, 57, 79	1561	91561
JEEP INDUSTRIAL						
All	6	225 engine	Delco	19, 43, 79	1165	
All	6	232 engine	Delco 1110340, 366, 0444	56, 57, 79	1162A	91162A
JOHN DEERE						
1962-72	4	500, 500C 3020 Series Tractor	Delco 1112474, 1112648	24, 55, 57, 79	1145A	91145A
1962-70	6	600, 4020 Series Tractor	Delco 1112624	56, 57, 79	1163A	91163A
1971-72	6	420	Delco 1112466	56, 57, 79	1163A	91163A

FOOTNOTES

- | | | |
|-----------------------------------------------------------------------------------------------------------------------------------------------------------------------------------------------------------------------------------------------------------------------------------------------------------|---------------------------------------------------------------------------------------------------------------------------------------------------------------------------------------------------------------------------------------------------------------------------------------------------------------------------------------------------------------------------------------------------------------------------|----------------------------------------------------------------------------------------------------------------------------------------------------------------------------------------------------------------------------------------------------|
| <p>2 Factory electronic ignition</p> <p>8 Single point distributor</p> <p>13 Lobe sensor module</p> <p>17 Small cap distributor</p> <p>19 Mechanical advance at top of shaft</p> <p>20 Large cap distributor</p> <p>21 See page 56 for complete replacement distributors</p> <p>22 Clockwise rotation</p> | <p>24 Counter clockwise rotation</p> <p>29 Excluding distributor number IAD-4036</p> <p>33 Vacuum advance distributor</p> <p>34 Non vacuum advance distributor</p> <p>43 Odd fire engine</p> <p>55 Ignitor version available in 6V negative ground, add N6 suffix</p> <p>56 Ignitor version available in 6V positive ground, add P6 suffix</p> <p>57 Ignitor version available in 12V positive ground, add P12 suffix</p> | <p>68 Overhead view of Ford distributor shaft ●</p> <p>69 Overhead view of Motorcraft distributor shaft ●</p> <p>79 Not for use with solid core spark plug wires</p> <p>110 Excluding distributor number IGW-4181C</p> <p>120 Except IGW-4181C</p> |
|-----------------------------------------------------------------------------------------------------------------------------------------------------------------------------------------------------------------------------------------------------------------------------------------------------------|---------------------------------------------------------------------------------------------------------------------------------------------------------------------------------------------------------------------------------------------------------------------------------------------------------------------------------------------------------------------------------------------------------------------------|----------------------------------------------------------------------------------------------------------------------------------------------------------------------------------------------------------------------------------------------------|

Year	Cyl	Model	Distributor Notes	Footnotes	Ignitor	Ignitor II
KAISER JEEP						
All	4	FJ, F4-134, L4-134	AutoLite IAD-4008A,4041	55, 56, 57, 79	1541	91541
KOMATSU						
All	4	Hercules 1600 engine	Prestolite	2, 79	2542	92542
1990	4	Nissan engines	Mitsubishi	79	1943	91943
1990	4	Nissan engines	Hitachi	79	1741	91741
All	6	P-40 engine	Hitachi	79	1761	91761
LE ROI						
All	4	D-71, K-3, W, X, V, Y	AutoLite IGW Series	55, 56	1545	91545
All	4	D-133, D-140, V, W, W-3, X, Y	AutoLite IGW-4121A	55, 56, 79	1545	91545
LINCOLN WELDERS						
1978-82	4	All models	Prestolite IBT-4705	21, 55, 57, 79	1542	91542
1962-66	6	Hercules JXD, QXLD-5 engine	Prestolite IGC-6001-2D	56, 57, 79	1561	91561
LYCOMING SPENCER ENGINES						
All	4	CV-4-180	AutoLite IAD-6004-1G	55, 56, 57, 79	1541	91541
MASSEY FERGUSON						
1956-59	4	MHF-3, 4	AutoLite IAD-6004-2H	55, 56, 57, 79	1541	91541
1963-64	4	MF-202, 204, 356 Tractor	Delco 1112643	24, 55, 57, 79	1145A	91145A
1966-68	4	MF-302, 304, 356, 2135, 2200, 2500, 3165	Delco 1112643	24, 55, 57, 79	1145A	91145A
1969	4	MF-3165 Tractor	Delco 1112458	24, 55, 57, 79	1145A	91145A
1971-78	4	MF-30 Tractor	Delco 1112458	24, 55, 57, 79	1145A	91145A
1974-78	4	MF-4000, MF-4500, MF6000	Delco 1112693	24, 55, 57, 79	1145A	91145A
All	4	MF302, 304, 356 (Continental GF-193 engine)	Delco 1112644	24, 55, 57, 79	1145A	91145A
All	4	MF2135, MF2200, MF2500 (Continental engine)	Delco	24, 55, 57, 79	1145A	91145A
All	6	MF1100, MF1105 (Waukesha F320G, LPG)	Delco	56, 57, 79	1163A	91163A
MICHIGAN						
All	6	C16, C24, T6K, T64, T66, TLDT-20, TMDT-16, -20	Prestolite	56, 57, 79	1561	91561
MINNEAPOLIS-MOLINE						
1950-66	4	M (Hercules IBX engine)	Prestolite IAD-6003B	55, 56, 57, 79	1541	91541
1950-66	4	B (Continental Y-112 engine)	AutoLite IGW-4139	21, 56, 79	1545	91545
1962-78	4	MA-30, MA-40, MA-50 Lift Truck	Prestolite IBT-4702	55, 57, 79	1542	91542
1965-66	4	HD-220-4A Power Unit	Delco 1112671	24, 55, 57, 79	1145A	91145A
1965-71	4	HD-336A-4A Power Unit	Delco 1112660, 661	22, 57, 79	1146A	91146A
1966-68	4	MY-40, MY-60 Lift Truck	Delco 1112642, 671	24, 55, 57, 79	1145A	91145A
1968-72	4	MA-20, MA-25, WC-20, WC-25, WC-305 Lift Truck	AutoLite IGW-4303	55, 56, 79	1545	91545
1969-71	4	HD-220-4A Power Unit	Delco 1112642	24, 55, 57, 79	1145A	91145A
1950-66	6	D, L Chrysler 30 engine	Prestolite IAD-4039-1	56, 57, 79	1561	91561
1963-71	6	HD-425-6A, 504A-6A, 605A-6A, 800-6A Power Unit	Delco 1112638	56, 57, 79	1163A	91163A
1974-78	6	G-1400, 1600 (Hercules gas engine)	Prestolite IAD-6013	56, 57, 79	1561	91561
MITSUBISHI						
All	4	4G33 engine	Mitsubishi MD-009102	79	1941	91941
All	4	4G52 engine	Mitsubishi MD-025752	79	1942	91942
MOBILIFT						
All	4	M, MSA (Hercules IBX engine)	Prestolite IAD-6003, 4	21, 55, 56, 57, 79	1541	91541
All	4	MA-30, MA-40, MA-50	Prestolite IBT-4702	55, 57, 79	1542	91542
All	4	B (Continental Y-112 engine)	AutoLite IGW-4139	21, 55, 56, 79	1545	91545
All	6	D, L (Chrysler 30 engine)	Prestolite IAD-4039-1	56, 57, 79	1561	91561
NEW IDEA						
1965-72	6	701, 702 Power Unit	Delco	56, 57, 79	1163A	91163A
NEWARK OHIO CO.						
All	6	701 Power Unit (Continental F245 engine)	Delco 1111310	21, 56, 57, 79	1163A	91163A
ONAN						
All	4	(55-50 Willys engine)	Prestolite IAD-4008	55, 56, 57, 79	1541	91541
All	4	(56-55 Willys engine)	AutoLite IGW-4115	55, 56, 79	1545	91545
All	4	5GO, 6GO, HC, HQ	AutoLite IGW-4156C	55, 56, 79	1545	91545
All	4	All models	AutoLite IGW-4409A	55, 56, 79	1545	91545
All	6	15K, 25HN (5A, 6A engine)	Prestolite IAD-4039-1	56, 57, 79	1561	91561
PETTIBONE MERCURY						
1978-80	4	(F-163 Continental engine)	Prestolite IDJ-4008	2, 21, 79	2542	92542
1979-82	6	All models	Prestolite IDJ-4013	21, 55, 57, 79	1562	91562
READY POWER						
All	4	F2, F4 (Ford engine)	Prestolite IAD-4008	55, 56, 57, 79	1541	91541
All	4	Z, Z-2 (Hercules ZXB engine)	AutoLite IGW-4120B	55, 56, 79	1545	91545
All	6	1959, F, L2, L3, V	Prestolite IAD-6002-1G	56, 57, 79	1561	91561

Year	Cyl	Model	Distributor Notes	Footnotes	Ignitor	Ignitor II
REO						
1954-66	8	OV-195, 207, 235, 390, 440 engines	Delco	79	1181	91181
1966-71	8	130B, 145B, engine	Holley D-4141A	79	1481	91481
1966-77	8	OV-235, B engine	Holley D-4292A, -1A, AAS	79	1481	91481
ROSS CARRIER						
All	4	Series 5 Lift Truck	Prestolite IAD-6004-2C	55, 56, 57, 79	1541	91541
All	6	Series 12T, Y200 Lift Truck, Series 80, 90, 100 Carrier	Prestolite IAD Series	56, 57, 79	1561	91561
SEAMAN AND WALL						
All	6	GS7C	Prestolite IAD-6002-1A	56, 57, 79	1561	91561
TCM						
All	4	FG, FCG 10-25 Series Lift Truck (Nissan H-20 engine)	Hitachi	79	1741	91741
All	6	FG, FCG 30, 35 Series Lift Truck (Nissan H-30 PPU)	Hitachi	79	1761	91761
TEREX DIVISION (G.M.C.) (WITH CONTINENTAL ENGINE)						
1972	4	T-30, 40, 50, 60, V-30, 40, 41, 50, 51, 60, Lift Truck	Delco 1112677	24, 55, 57, 79	1145A	91145A
1972	6	540, 600, 670, 760-P, 860-P, 960-PLT	Delco 1112444	22, 56, 57, 79	1163A	91163A
1972	6	V-30, 40, 41, 50, 51, 60	Delco 1112444	22, 56, 57, 79	1163A	91163A
THERMO-KING						
All	4	Thermo King MQ-21 Refrig. Unit	Prestolite IAD-4038	55, 56, 57, 79	1541	91541
All	4	Waukesha 1CK engine	Prestolite IAD-6004A	55, 56, 57, 79	1541	91541
TOWMOTOR						
1950-51	4	LT-40, 44, 48, 50, 60	Auto-lite IGW-4044A	55, 56, 79	1545	91545
1950-56	4	LT-35, 350	Auto-lite IGW-4044A, 4191A	55, 56, 79	1545	91545
1955-62	4	Continental Y-91 engine	Prestolite IAD-6004-1D	55, 56, 57, 79	1541	91541
1957-65	4	350 Lift Truck Continental N-62	Auto-lite IGW-4191A	55, 56, 79	1545	91545
1959-70	4	331 Lift Truck	Auto-lite IGW-4403A	55, 56, 79	1545	91545
1960-70	4	442, 462, 502P, 601P	Prestolite IBT-4701A	55, 57, 79	1542	91542
1962-70	4	502, 601	Prestolite IBT-4701C	55, 57, 79	1542	91542
1965-67	4	350 Lift Truck	Auto-lite IGW-4501	55, 56, 79	1545	91545
1966-73	4	Lift Truck Waukesha 1CK engine	Auto-lite IGW-4502	55, 56, 79	1545	91545
1970-79	4	Lift Truck	Prestolite IBT-4701C	55, 57, 79	1542	91542
1971-80	4	Continental F, Y engine	Prestolite IBT-4701C	55, 57, 79	1542	91542
1972	4	Lift Truck; T-30, 40, 50, 60; V30, 40, 41, 50, 51, 60	Delco 1112677	24, 55, 57, 79	1145A	91145A
1975-78	4	V60C Lift Trucks Perkins G4-236 engine	Prestolite IDJ-4005	2, 79	2542	92542
1976-80	4	V60-80 Lift Trucks Perkins G4-236 engine	Prestolite IDJ-4005A	2, 79	2542	92542
1978-79	4	All Y112, F163, F185 Continental engine	Prestolite IDJ-4012	2, 21, 79	2542	92542
1962	6	Lift Truck; 850, 950	Delco 1112622, 630	56, 57, 79	1163A	91163A
1972	6	Lift Truck; Continental F227 engine	Delco 1112444	56, 57, 79	1163A	91163A
1972-79	6	Lift Truck Continental F226, F245 engine	Prestolite IBT-6702	21, 55, 57, 79	1562	91562
1977	6	Continental F227, 245 engine	Prestolite IDJ-4013	55, 57, 79	1562	91562
1979	8	Large Lift Truck V345 engine	Prestolite IDN-4102B	2, 79	1485A	91485A
TOYOTA INDUSTRIAL						
All	4	4P	Nippondenso	13, 79, 119	1648LS	
All	4	5R	Nippondenso	13, 79, 119	1648LS	
All	4	FGC10, 02-FGC10, FGC15, 02-FGC15, 2FGC20, 02-2FGC20	Nippondenso	13, 79, 119	1648LS	
All	4	FGC25, 02-FGC25, FG25, 40-FG20, 42-FG20	Nippondenso	13, 79, 119	1648LS	
All	4	FG-25, FGC-15, FGC-25, 2FGC-20,	Toyota	79	1641	91641
All	4	3-FG-10, 15; 3-FGC-20, 25; 4-FGC-20, 25	Toyota	79	1641	91641
All	4	02-FG-25, 02-FGC-10, 02-FGC-15, 02-FGC-20,	Toyota	79	1641	91641
All	4	02-FGC-25, 40-FG-20, 42-FG-20	Toyota	79	1641	91641
All	4	FGC-10 (5R engine)	Toyota	79	1641	91641
All	6	2FG-50, 60, 3FG-32, 35, 40, 50, 60	Toyota	79	1661	91661
All	6	FG-32, 35, 40 (F engine), 2FG-32, 35, 40 (2F engine)	Toyota	79	1665A	91665A
UNIVERSAL						
All	4	AF	Auto-lite IGW-4116A	55, 56, 79	1545	91545
US MOTORS						
All	4	All models	Prestolite IAD-4037, 6004	55, 56, 57, 79	1541	91541
All	4	All models	Auto-lite IGW-4022, 120	56, 79	1545	91545
All	6	All models	Prestolite IAD-6002-1A	56, 57, 79	1561	91561



FOOTNOTES

- 2 Factory electronic ignition
- 13 Lobe sensor module
- 21 See page 56 for complete replacement distributors
- 22 Clockwise rotation
- 24 Counter clockwise rotation
- 55 Ignitor version available in 6V negative ground, add N6 suffix
- 56 Ignitor version available in 6V positive ground, add P6 suffix
- 57 Ignitor version available in 12V positive ground, add P12 suffix
- 79 Not for use with solid core spark plug wires
- 119 Early style distributor



Year	Cyl	Model	Distributor Notes	Footnotes	Ignitor	Ignitor II
VOLKSWAGEN INDUSTRIAL ENGINE						
1969-72	4	Type 122/2, Type 126/A	Bosch 231117007	79	1847V	91847V
1971-75	4	Type 127 (1m 127 engine)	Bosch 231117007	79	1847V	91847V
1973-75	4	Type 122/2, Type 126/A (1m 122 engine)	Bosch 231178003, 009	79	1847A	91847A
WAUKESHA						
1950-73	4	IC series	AutoLite IGW-4118A, 4301	55, 56, 79	1545	91545
1959-67	4	FC, FCS, FS14	AutoLite IGW-4301, 4303	55, 56, 79	1545	91545
1972-73	4	FC-4	Delco 1112455	24, 55, 57, 79	1145A	91145A
1972-74	4	18GKB	Delco 1112463, 470	22, 79	1146A	91146A
1975-78	4	VRG-155 engine	Delco 1112470	22, 79	1146A	91146A
All	4	H-1077G	Delco	24, 55, 57, 79	1145A	91145A
All	4	FC series	Delco 1112455	24, 55, 57, 79	1145A	91145A
All	4	180 DCK, GKB	Delco 1112463, 470	22, 79	1146A	91146A
All	6	FC	Delco 1111302	13, 79	1168LS	91168LS
1963-66	6	190	Delco 1112682	56, 57, 79	1163A	91163A
1967-70	6	265G, 283	Delco 1112682	56, 57, 79	1163A	91163A
1968-70	6	320G, LPG	Delco 1112687, 696	56, 57, 79	1163A	91163A
1968-73	6	F-554G Standard	Delco 1112465	56, 57, 79	1163A	91163A
1968-82	6	F-817G, F1197G Standard	Delco 1112465	56, 57, 79	1163A	91163A
All	6	135GZ	Delco 1112462	56, 57, 79	1163A	91163A
All	6	195GK, F320G	Delco 1112687, 96	56, 57, 79	1163A	91163A
WHITE						
1969-72	4	MY-40, 50, 60, 70	Delco 1112642	24, 55, 57, 79	1145A	91145A
1972	4	HD-425A-6A, 336A-4 1, 504A-6A, 605B-6A, 800-6A	Delco 112660, 661	22, 79	1146A	91146A
1975-81	4	MA20, 25, 30, Lift Truck	Delco 1112487	24, 55, 57, 79	1145A	91145A
1976-82	4	Misc. models	Prestolite IBT-4702, 4405	55, 57, 79	1542	91542
1977-83	4	G-1600	Prestolite IAD-6013	55, 56, 57, 79	1541	91541
1969-74	6	MA20 thru MA100, WC-20, 30, 40, 50	Delco 1112444	56, 57, 79	1163A	91163A
1975-81	6	MA60H, 70, 80, 90, 100, 120 Lift Truck	Delco 1112444	56, 57, 79	1163A	91163A
1966-69	8	470 cid. engine	Holley D-4108A	79	1481	91481
WILLYS INDUSTRIAL						
All	4	All models	AutoLite IAD-6004	21, 55, 56, 57, 79	1541	91541
WISCONSIN						
1950-90	1	All models	AutoLite IGW-Series	55, 56, 57, 79	1511	
1955-60	1	ACN, AENL, BKN	AutoLite IGW-4179	55, 56, 79	1511	
1955-65	1	ABN, ACH, AEH, AEN, AENS, AFH, AHH, AKS	AutoLite IGW-4167	55, 56, 79	1511	
1960-61	1	ACN, AENL, AGND, BKN	AutoLite IGW-4402, 05	55, 56, 79	1511	
1950-65	4	VP4, VP4D	AutoLite IGW-4187A	55, 56, 79	1545	91545
1953-67	4	VG4D, VH4, VH4D, VH4DM, VR4, VR4D	Prestolite IAD-6004-2F	21, 55, 56, 57, 79	1541	91541
1961-64	4	V460D	Prestolite IAD-6004-2F	21, 55, 56, 57, 79	1541	91541
1968-79	4	VG4D, VH4, VH4D, VH4DM, V461D	Prestolite IAD-6004-2N, 2R	21, 55, 56, 57, 79	1541	91541
1969-73	4	LTV All Terrain Vehicle (VH engine)	Prestolite IAD-6012	55, 56, 57, 79	1541	91541
1982	4	V461D, V465D	Prestolite IAD-6004-2N	21, 55, 56, 57, 79	1541	91541
1983	4	Misc. models	Prestolite IBT-4709	55, 57, 79	1542	91542
All	4	VE4D, VPO-4	AutoLite IGW-4159A	55, 56, 79	1545	91545
All	4	VE4, VF4, VF4D, VP4, VP4D	AutoLite IGW-4151, 59	55, 56, 79	1545	91545
All	4	V460D, 461D, 465D	Delco 1112695	24, 55, 57, 79	1145A	91145A
WORTHINGTON						
All	4	60 (Continental Y-91 engine)	Prestolite IAD-4206, 6004	55, 56, 57, 79	1541	91541
All	6	150, 160, 210 (F6-226, M-330, B6-427 engine)	Prestolite IAD-4027, 6002	56, 57, 79	1561	91561

APPLICATION NOTES

The following pages represent the most common Ignitor electronic conversions for agricultural applications. To assist in selecting the correct part number, use the following general guidelines:

- Read all footnotes before ordering
- Applications are based on the original equipment. For kits listed by distributor make and part number, turn to page 19
- Some kits use Lobe Sensor Modules, which senses the point cam and do not use a magnet sleeve or ring
- Applications may have Ignitor or Ignitor II kits available. The part numbers for each version are found in their respective columns. Refer to page 2 & 3 for an extended description of features and a comparison chart
- Unless otherwise noted, the part numbers in this catalog represent 12-volt negative ground kits. Many of our standard Ignitor applications are also available in 6-volt negative ground, as well as 6 and 12-volt positive ground. To order these special variations simply add a N6, P6 or P12 to the end of the part number when ordering. Ignitor II kits are only available in 12-volt negative ground
- Compatible coils can be found in the coil section of this catalog
- As with all modern electronics, our modules must not be used with solid core spark plug wires. Suppression core spark plug wires can be found in the spark plug wire section of this catalog
- If your application can not be found in this catalog please visit www.pertronix.com or call us at (909) 547-9058 for updated application information

Year	Cyl	Model	Distributor Notes	Footnotes	Ignitor	Ignitor II
ALLIS CHALMERS						
All	4	D17	Delco 1111735	55, 56, 57, 79	1142	91142
All	4	Baler models 300, 302, 303	Prestolite IAD-6004	21, 55, 56, 57, 79	1541	91541
All	4	Sprayer '2300	Prestolite IAD-6004	21, 55, 56, 57, 79	1541	91541
All	4	Tractor models 170, 175	Delco 1112688	22, 57, 79	1146A	91146A
All	6	models E, E-111, K	Delco 1112479, 640	56, 57, 79	1163A	91163A
All	6	F, G262, B, GB230, G250, G292 engine	Delco 1112461, 479, 640	56, 57, 79	1163A	91163A
All	6	G, 2800 (gas engine)	Delco 1112472	56, 57, 79	1163A	91163A
All	6	K, 6-250, 6-232 engine	Delco 1112479	56, 57, 79	1163A	91163A
All	6	180, 190XT, 200, 226	Delco 1112668	56, 57, 79	1163A	91163A
All	6	190 (G-2500 gas, LPG engine)	Delco 1111311, 2653, 667	56, 57, 79	1163A	91163A
BESLER						
All	4	450 Wisconsin VG4	Prestolite IAD-6004	21, 55, 56, 57, 79	1541	91541
BOLENS						
All	4	Wisconsin VG4D	Prestolite IAD-6004	21, 55, 56, 57, 79	1541	91541
BRADY						
All	4	BPO60-DKB, T60DKM (Wisconsin VG4D)	Prestolite IAD-6004	21, 55, 56, 57, 79	1541	91541
CARDOX						
All	4	Jeep F-4 engine	Prestolite IAD-4041	55, 56, 57, 79	1541	91541
All	4	Wisconsin engine VG4D	Prestolite IAD-6004	21, 55, 56, 57, 79	1541	91541
CASE						
All	4	700, 730, 734, 740, 770, 800, 830 Tractors	Wico X30091E	24, 55, 56, 57, 82, 79	W0-141A	9W0-141A
All	4	840, 870, 900B, 930, 940, 970 Tractors	Wico X30091E	24, 55, 56, 57, 82, 79	W0-141A	9W0-141A
All	4	W5 G188 engine	Prestolite IAD-6003	55, 56, 57, 79	1541	91541
All	4	177 Wisconsin VG4D	Prestolite IAD-6004	21, 55, 56, 57, 79	1541	91541
All	4	330 (Wisconsin VG4D, VH4D)	Prestolite	55, 56, 57, 79	1541	91541
All	4	65 Wisconsin VF4	Prestolite	55, 56, 57, 79	1541	91541
All	4	150, 302, 400, 600, 660, (Hercules G-188B, A201)	Prestolite	55, 56, 57, 79	1541	91541
All	4	200, 300 (Continental F140 engine)	Prestolite IAD-6004	55, 56, 57, 79	1541	91541
All	4	300, 400, 500 (Continental F162, FA162 engine)	Prestolite IAD-6004	55, 56, 57, 79	1541	91541
All	4	310, 320, G148	Prestolite IAD-6003	55, 56, 57, 79	1541	91541
All	4	440, 640 G148, G188 engine	Prestolite IAD-6003	55, 56, 57, 79	1541	91541
All	4	GT25, 30, 34 (Continental F124, F140, F162 engine)	Prestolite IAD-6004	55, 56, 57, 79	1541	91541
All	4	W5 G188 engine	Prestolite IAD-6003	55, 56, 57, 79	1541	91541
All	4	S, VA Series	Prestolite IAD-6003	55, 56, 57, 79	1541	91541
All	4	200, B, 210, B, 211B G126, 148, 188 engine	Prestolite	55, 56, 57, 79	1541	91541
All	4	200B, 350, 351, 400B, 500B, 600B, (G126, G164)	Prestolite IAD-6003	55, 56, 57, 79	1541	91541
FOOTNOTES						
13	Lobe sensor module		55	Ignitor version available in 6V negative ground, add N6 suffix	82	Will not fit magneto type distributors
21	See page 56 for complete replacement distributors		56	Ignitor version available in 6V positive ground, add P6 suffix		
22	Clockwise rotation		57	Ignitor version available in 12V positive ground, add P12 suffix		
24	Counter clockwise rotation		79	Not for use with solid core spark plug wires		



Year	Cyl	Model	Distributor Notes	Footnotes	Ignitor	Ignitor II
CASE (CONTINUED)						
All	4	300, 310, 320, (G148)	Prestolite IAD-6003	55, 56, 57, 79	1541	91541
All	4	350, 351, 500B, 600B, (G164)	Prestolite IAD-6003	55, 56, 57, 79	1541	91541
All	4	400, 440, 441, 80CK (G148, B)	Prestolite IAD-6003	55, 56, 57, 79	1541	91541
All	4	540, C541, C (159); 640, 641, C	Prestolite IAD-6003	55, 56, 57, 79	1541	91541
All	4	400B, 420, 430, 435LCK, 440, 441, 450, 500	Prestolite	55, 56, 57, 79	1541	91541
All	4	400 (F162 engine)	Prestolite	55, 56, 57, 79	1541	91541
All	4	530, 30LCK, 540, 41, C, C570, 80, CK, CK-B	Prestolite IAD-6003	55, 56, 57, 79	1541	91541
All	4	600B, G30, 640, C, 641, C	Prestolite	55, 56, 57, 79	1541	91541
All	4	700B, 800, 800B, 900B	Prestolite	55, 56, 57, 79	1541	91541
All	4	650, 655, 675 (Wisconsin VH4D, VG4D engine)	Prestolite	55, 56, 57, 79	1541	91541
All	4	1150, 1155, (G159), 1255 (G188)	Prestolite IAD-6003-2F	21, 55, 56, 57, 79	1541	91541
All	4	V461D; (Own G159, G188, B)	Prestolite	55, 56, 57, 79	1541	91541
All	4	800 (Hercules GO-298 A-251G, A-284G-F engine)	Prestolite	55, 57, 79	1542	91542
All	4	1000, 1010 (Hercules GO-289 A-215G, A-284G-F)	Prestolite	55, 57, 79	1542	91542
All	4	W7, W9AG 284 engine	Prestolite IBT-4402	55, 57, 79	1542	91542
All	4	W5AG 188 engine	Prestolite IBT-4403A	55, 57, 79	1542	91542
All	4	470 (G148, B, G159 engine)	Prestolite IAD-6003	55, 57, 79	1541	91542
All	4	680CK A267	Prestolite	55, 57, 79	1542	91542
All	4	251, A301GB; 830, 840, 870	Prestolite	55, 57, 79	1542	91542
All	4	NCM, NT Wisconsin VE4	Auto-lite IGW-4159A	56, 57, 79	1545	91545
All	4	A Wisconsin VF4	Auto-lite IGW-4159A	56, 57, 79	1545	91545
All	4	V, VC, VI, VO Continental F124 engine	Auto-lite	56, 57, 79	1545	91545
All	4	840 (Wisconsin VE4; Own A -125 engine)	Auto-lite IGW-4159A	56, 57, 79	1545	91545
All	6	600, 600G, 800G (Continental F209; H227 engine)	Prestolite IAD-6002-1G	56, 57, 79	1561	91561
All	6	900 (gas and LPG engine)	Prestolite IAD-6010-1	56, 57, 79	1561	91561
All	6	970 (377BG, A401 engine)	Prestolite	55, 57, 79	1562	91562
CENTAUR						
All	4	Hi-Way Mower, KV Tractor	Auto-lite IGW-4121A	56, 57, 79	1545	91545
COCKSHUTT						
All	4	7, 18, 422 (Continental F-124, 140 engine)	Prestolite IAD-6004	55, 56, 57, 79	1541	91541
All	4	101, 102, 103, 620, 720 (Wisconsin engine)	Prestolite IAD-6004	21, 55, 56, 57, 79	1541	91541
All	4	10, 12, 14, 16 Ft., 502 Windrower	Prestolite IAD-6004	21, 55, 56, 57, 79	1541	91541
All	4	20, 30, (Continental F-124, 140 engine) GO-198	Prestolite IAD-6004	56, 57, 79	1541	91541
All	6	SP-109, 110, 112, 115, 132, 137, 215, 420	Prestolite IAD-4040-1	56, 57, 79	1561	91561
All	6	427, 28, 29; 430, 431, 525, 535, 542, 545	Prestolite IAD-4040-1	56, 57, 79	1561	91561
All	6	40 (Chrysler T- 120, 8A engine)	Prestolite IAD-4203-1	56, 57, 79	1561	91561
CUSTOM						
All	6	B, C, E, ER, EW, HR, HW	Prestolite IAD Series	56, 57, 79	1561	91561
FORD						
All	3	Series 2000, 2100, 2110, 3100, 3400	FoMoCo	79	1231	
All	3	Series 4000, 4100, 4140, 4200	FoMoCo	79	1231	
1939-50	4	2N, 9N	FoMoCo	23, 56, 79	1247	91247
All	4	8N	FoMoCo	23, 56, 79	1247	91247
All	4	8N, series 500 thru 900	FoMoCo	25, 55, 56, 57, 79	1244A	91244A
All	4	2N, 8N, 9N	FoMoCo	23, 31, 56, 79	1247XT	91247XT
All	4	16-46, 47, 48, 49; 16-98, 99, 100, 101	Prestolite	55, 56, 57, 79	1541	91541
All	4	17-14, 15, 16, 17 Wisconsin VF4D	Prestolite	55, 56, 57, 79	1541	91541
All	4	19-14, 15, 16, 17	Prestolite	55, 56, 57, 79	1541	91541
1965-76	4	5000, 5100, 5000 Super, 5200, 6000, 6600	FoMoCo	79	1249	91249
All	6	17-1, 17-34, 17-35	Auto-lite	69, 79	1261	91261
All	6	630, 640 Ford 300 engine	Auto-lite	69, 79	1261	91261
FOX RIVER						
1958-59	6	Forage Harvester	Prestolite IAD-6002-1G	56, 57, 79	1561	91561
FRIEND						
All	4	ATB, ATB40, CU32, CU32RC, GTA, GTAT50, MA36	Prestolite	21, 55, 56, 57, 79	1541	91541
All	4	MA36, MA36RC, MAL36RC; 322, 362,	Prestolite IAD-6004	21, 55, 56, 57, 79	1541	91541
GEHL (FORAGE HARVESTER)						
All	4	HL3030 Hydra Cat.	Prestolite IAD-6004-2N	21, 55, 56, 57, 79	1541	91541
All	4	Wisconsin VG4D engine	Prestolite IAD-6004-2F	21, 55, 56, 57, 79	1541	91541
All	6	Continental FA-244, M-363 engine	Prestolite IAD-6002-	56, 57, 79	1561	91561
GRAHAM BRADLEY TRACTOR						
NEW	1937-38	6	Delco 1110502	55, 56, 57, 79	2162	92162
HAGIE						
All	4	320, 340, 430, 432, 435, W; 437 Crane	Prestolite IAD-6004-2F	21, 55, 56, 57, 79	1541	91541
All	4	H300, FSP, P, H306, FSP, P	Prestolite IAD-6004	21, 55, 56, 57, 79	1541	91541
All	4	Hi. Boy, FS, Sprayer & Power Unit, VH4D engine	Prestolite IAD-6004	21, 55, 56, 57, 79	1541	91541

Year	Cyl	Model	Distributor Notes	Footnotes	Ignitor	Ignitor II
HARDIE MFG. CO.						
All	4	Wisconsin VG4D	Prestolite IAD-6004	21, 55, 56, 57, 79	1541	91541
All	4	DF24B, DF480C, DF485C, F4 engine	Prestolite IAD-4012, 41	21, 55, 56, 57, 79	1541	91541
All	4	VP4D (Wiscon engine)	Prestolite IGW-4159A	56, 57, 79	1545	91545
All	6	150-160 Continental F-226 engine	Prestolite	55, 56, 57, 79	1561	91561
HARRINGTON						
All	4	Combine	Prestolite IAD-6004-2F	21, 55, 56, 57, 79	1541	91541
HESSTON						
All	4	110, 180, 260, 280, 300, 310 (Wiscon engine)	Prestolite IAD-6004	21, 55, 56, 57, 79	1541	91541
All	4	HS220, HS240, HS260, HS500 (Wiscon engine)	Prestolite IAD-6004	21, 55, 56, 57, 79	1541	91541
INTERCONTINENTAL						
All	4	C-26 (Continental F126, Buda 4BD-153 engine)	Prestolite IAD-4029, 6004	21, 55, 56, 57, 79	1541	91541
INTERNATIONAL HARVESTER						
All	4	All models with IH distributors	IH	55, 56, 57, 79	1442	91442
All	4	Combine (Wisconsin VRDD engine)	Prestolite IAD-6004-2F	21, 55, 56, 57, 79	1541	91541
All	4	Baler (Wisconsin VG4D, VH4D engine)	Prestolite	55, 56, 57, 79	1541	91541
All	4	37T, 37 W, 47T, 47W, 57T, 57W, 71W	Prestolite IAD-6004-2N	21, 55, 56, 57, 79	1541	91541
All	4	45, 46 (Wisconsin VF4)	Prestolite	55, 56, 57, 79	1541	91541
All	4	47 Twine, 47 Wire (Wisconsin VH4D, VH4)	Prestolite	55, 56, 57, 79	1541	91541
All	4	56, 57 Twine & Wire (Wisconsin VH4D, VH4 engine)	Prestolite	55, 56, 57, 79	1541	91541
All	4	60, 70, 71 Wire (Wisconsin VG4D, VR4D engine)	Prestolite	55, 56, 57, 79	1541	91541
All	4	430, T, W, 440, T, W, (Wisconsin engine.)	Prestolite	55, 56, 57, 79	1541	91541
All	4	3414 (BC144 engine)	Lucas	79	LU-145	9LU-145
All	4	C-157, C-175, C-200	Prestolite IBT-4102A	55, 57, 79	1542	91542
All	4	574 (C-200, D-239)	Prestolite	55, 57, 79	1542	91542
All	4	544, 574, 674 (C-200, D-239)	Delco	55, 57, 79	1145A	91145A
All	4	2544 (C-200, D-239 engine)	Delco	55, 57, 79	1145A	91145A
All	4	3514 (C-153, C-175 engine)	Delco	55, 57, 79	1145A	91145A
All	4	Wisconsin VF4D engine	Prestolite	55, 56, 57, 79	1541	91541
All	4	80 Wisconsin VH4 engine	Prestolite	56, 57, 79	1541	91541
All	4	140 Wisconsin VR4D engine	Prestolite IAD series	56, 57, 79	1541	91541
NEW 1938-40	6	TD	Delco 1110501	55, 56, 57, 79	2162	92162
1970-71	6	UB-220, 265, UR-450, UV-450 Power Unit	Delco 1112471, 1112473	56, 57, 79	1163A	91163A
1970-73	6	H30B, F, R Payloader	Delco 1112471	56, 57, 79	1163A	91163A
All	6	Windrower 4000 (C232, 258 engine)	Delco 1110523, 528	79	1162A	91162A
1959-64	8	UV-345, UV-549 Power Unit	Delco 1112755, 44, 48, 49, 82	79	1181	91181
JOHN BEAN						
1957-73	4	All Wiscon (VE4D, VE4, VF4D, VG4D, VH4D, VP4D)	Prestolite IAD-6004	21, 55, 56, 57, 79	1541	91541
1957-73	4	E200CP, E277, G200CP	Prestolite IAD-4041	55, 56, 57, 79	1541	91541
1958-59	4	All with (Willys F4 engine)	Prestolite IAD-4041	55, 56, 57, 79	1541	91541
1960-72	4	28E, G	Prestolite IAD-4041	55, 56, 57, 79	1541	91541
All	4	60 (F-2 engine)	Prestolite IAY-4401	55, 56, 57, 79	1541	91541
All	4	277, E277 (F4-134 engine)	Prestolite	55, 56, 57, 79	1541	91541
1958-63	6	40RC, 300G Rotomist with Chrysler Ind 32 engine	Prestolite IAD-4040-1	56, 57, 79	1561	91561
All	6	557CP (GM 305C)	Delco	56, 57, 79	1163A	91163A
All	8	700CP (GM 370)	Delco	79	1181	91181
All	8	703CP, 757CP (IHC 345 V8)	Delco	79	1181	91181
JOHN BLUE						
All	4	Wisconsin VH4, VH4D	Prestolite IAD-6004-2F	21, 79	1541	91541
JOHN DEERE						
All	4	8 Forage Harvester	Prestolite IAD-4029	21, 55, 56, 57, 79	1541	91541
All	4	72, 74 (Wisconsin VP4D engine)	Prestolite	55, 56, 57, 79	1541	91541
All	4	10 Wisconsin VG4D engine	Prestolite	55, 56, 57, 79	1541	91541
All	4	214WS, 216T, 216W, WS, 224T, 224WS	Prestolite IAD-6004-2N	21, 55, 56, 57, 79	1541	91541
All	4	346 (Wisconsin VG4D, VH4D engine)	Prestolite IAD-6004-2N	21, 55, 56, 57, 79	1541	91541
All	4	4020 Hercules, Wisconsin engine	Prestolite	55, 56, 57, 79	1541	91541
All	4	600, 700	Prestolite	55, 57, 79	1542	91542
All	4	780 (Wisconsin VG4D, VH4D engine)	Prestolite	55, 57, 79	1542	91542
All	4	500, 500C	Delco 1112474, 1112648	55, 57, 79	1145A	91145A
Al	4	1010, 2010 Tractors	Autolite IBT-4101	24, 55, 56, 57, 79, 82	1544	91544
Al	4	1010, 2010 Tractors	Wico X30091E	24, 55, 56, 57, 79, 82	WO-141A	9WO-141A
All	4	3010	Delco 1112623	55, 57, 79	1145A	91145A
All	4	3020	Delco 1112474, 2623, 48	55, 57, 79	1145A	91145A

FOOTNOTES

21 See page 56 for complete replacement distributors
 23 Front mount distributor
 24 Counter clockwise rotation
 25 Side mount distributor

31 Remote mount coil conversion kit included
 55 Ignitor version available in 6V negative ground, add N6 suffix
 56 Ignitor version available in 6V positive ground, add P6 suffix
 57 Ignitor version available in 12V positive ground, add P12 suffix

69 Overhead view of Motorcraft distributor shaft
 79 Not for use with solid core spark plug wires
 82 Will not fit magneto type distributors

Year	Cyl	Model	Distributor Notes	Footnotes	Ignitor	Ignitor II
JOHN DEERE (CONTINUED)						
All	4	Windrower 10, 14, 16 Ft.	Prestolite IAD-6004-2F	21, 79	1541	91541
All	6	55	Prestolite IAD-4012A	56, 57, 79	1561	91561
All	6	99, 299SP NP-217G, L	Prestolite	55, 57, 79	1562	91562
All	6	12 Deere EA-217 engine	Prestolite	55, 57, 79	1562	91562
All	6	95, 105	Delco 1112466	56, 57, 79	1163A	91163A
All	6	Combine 4400, 4400SP, 6602, 7700, 7700SP	Delco 1112466, 640	56, 57, 79	1163A	91163A
All	6	600, 700, 4000, 4010	Delco 1112624	56, 57, 79	1163A	91163A
All	6	4020	Delco 1112466, 624	56, 57, 79	1163A	91163A
All	6	800 Chrysler 225 engine	Chrysler	79	1361A	91361A
All	6	800 Chrysler 225 engine	Prestolite	56, 57, 79	1561	91561
All	6	Harvester H-7	Delco 1112466	56, 57, 79	1163A	91163A
JUMBO						
All	6	B, C, E, ER, EW, HR, HW	Prestolite IAD series	56, 57, 79	1561	91561
KROMER						
All	4	Wisconsin VF4, VH4, VH4D	Prestolite IAD-6004-2F	21, 55, 56, 57, 79	1541	91541
LILLISTON						
All	4	Peanut Combine	Prestolite IAD-6004-2F	21, 55, 56, 57, 79	1541	91541
All	4	04, 1500, 2, 8 (Wisconsin VG4D, VH4, VH4D engine)	Prestolite IAD-6004-2N	21, 55, 56, 57, 79	1541	91541
LONG						
All	4	680 Baler Wisconsin VH4D engine	Prestolite IAD-6004-2N	21, 55, 56, 57, 79	1541	91541
All	4	A Tractor Continental F-162 engine	Prestolite IAD-6004-1B	55, 56, 57, 79	1541	91541
All	4	50, 60 Baler (Wisconsin VB4, VF4 engine)	Auto-lite IGW-4159A	55, 56, 79	1545	91545
LOVE						
All	4	J-51 Willys CJ2A, 3 engine	Prestolite IAD-4008	55, 56, 57, 79	1541	91541
All	6	CF1, CF51, (Chrysler 5A, 6A engine)	Prestolite IAD-4039, 4201	56, 57, 79	1561	91561
LUNDELL						
All	4	2020 Tractor, Forage Harvester Super 606	Prestolite IAD-6004	21, 55, 56, 57, 79	1541	91541
All	6	55-17 Continental F224 engine	Prestolite IAD-6002-1G	56, 57, 79	1561	91561
MASSEY FERGUSON						
All	3	MF235	Delco 1112457	79	1131	
All	4	35SP, 72 Ft. Continental F140 engine	Prestolite IAD-6004-ID	55, 56, 57, 79	1541	91541
All	4	60, 72 Pulled Type Continental F-140 engine	Prestolite	55, 56, 57, 79	1541	91541
All	4	Clipper Continental F-162 engine	Prestolite	55, 56, 57, 79	1541	91541
All	4	MHF3, MHF4 (Continental engine)	Prestolite	55, 56, 57, 79	1541	91541
All	4	MJA382, D (Continental engine)	Prestolite	55, 56, 57, 79	1541	91541
All	4	11 Pony, 16 Pacer, 21 Colt, 22K, 23K, 23	Prestolite	55, 56, 57, 79	1541	91541
All	4	Mustang, 30, K, 33, 44 (Continental engine)	Prestolite	55, 56, 57, 79	1541	91541
All	4	55 Continental J-382 engine	Prestolite	55, 56, 57, 79	1541	91541
All	4	333, RT, RS, HA, 444, 555 (Continental engine)	Prestolite	55, 56, 57, 79	1541	91541
All	4	50 Wisconsin VF4 engine	Auto-lite IGW-4150, 4151	55, 56, 57, 79	1545	91545
All	4	Clipper 6 ft., 7 ft. (Wisconsin VF4 engine)	Auto-lite	55, 56, 57, 79	1545	91545
All	4	MF20 Wisconsin VF4 engine	Auto-lite IGW-4159A	55, 56, 57, 79	1545	91545
All	4	TO20, TO30 (Continental Z120 & Z129 engine)	Delco 1111740	24, 28, 56, 57, 79	1143	91143
All	4	TO35, 50, MH50 (Continental Z129 & Z134 engine)	Delco 1112557, 1112570	24, 28, 56, 57, 79	1143	91143
All	4	65 (G176 engine)	Delco 1112583, 1112589	24, 28, 56, 57, 79	1143	91143
All	4	F40 Continental Z-134 engine	Delco 1112643	55, 57, 79	1145A	91145A
All	4	H-260 Continental H-260 engine	Delco	55, 57, 79	1145A	91145A
All	4	MF Special 35, MF50 (Continental Z-134 engine)	Delco 1112643	55, 57, 79	1145A	91145A
All	4	MF65 Continental G-176 engine	Delco 1112643, 644	55, 57, 79	1145A	91145A
All	4	MF-135, MF-150, MF-165	Delco 1112643, 644	55, 57, 79	1145A	91145A
All	4	MF-175, MF-180	Delco 1112647, 693	55, 57, 79	1145A	91145A
All	4	MF-2135, MF2200, MF2500, MF-3165	Delco 1112644	55, 57, 79	1145A	91145A
All	4	MF255, 265	Delco 1112458, 693	55, 57, 79	1145A	91145A
All	4	MF285 Perkins AG4-236 engine	Delco 1112693	55, 57, 79	1145A	91145A
All	4	MF-6500	Delco 1112693	55, 57, 79	1145A	91145A
All	4	Swather MF-36	Delco 1112448, 478	22, 57, 79	1146A	91146A
All	6	Combine (Chrysler 5, 5A, 30, 251 engine)	Prestolite IAD-4039-1	56, 57, 79	1561	91561
All	6	27 (Chrysler 8A, 30, 251, 265 engine)	Prestolite IAD-4040-1	56, 57, 79	1561	91561
All	6	60SP, 70, 72SP, 80SP, 82SP, (Chrysler 5, 30, 251)	Prestolite IAD-4039-1	56, 57, 79	1561	91561
All	6	90SP, 92 (Chrysler 8A, 30, 251, 265 engine)	Prestolite IAD-4040-1	56, 57, 79	1561	91561
All	6	Clipper Forager Continental F-226 engine	Prestolite	56, 57, 79	1561	91561
All	6	44-6 Continental F-226 engine	Prestolite	56, 57, 79	1561	91561
All	6	MF410 GMC 292	Delco	56, 57, 79	1163A	91163A
All	6	MF-1100, MF-1105 (gas and LPG engine)	Delco 1112687, 696	56, 57, 79	1163A	91163A
All	6	MF-410-292 engine	Delco 1112479, 640	56, 57, 79	1163A	91163A

Year	Cyl	Model	Distributor Notes	Footnotes	Ignitor	Ignitor II
MINNEAPOLIS-MOLINE						
All	4	Combine G12.	Prestolite IAD-6004-2F	21, 55, 56, 57, 79	1541	91541
All	4	69, 88 Wisconsin VE4 engine	Prestolite	55, 56, 57, 79	1541	91541
All	4	A (Hercules IX43, B3, K3, engine)	Prestolite	55, 56, 57, 79	1541	91541
All	4	V ZXB-3 engine	Prestolite	55, 56, 57, 79	1541	91541
All	4	Windrower	Prestolite IAD-6004-2F	21, 55, 56, 57, 79	1541	91541
All	4	G900, 1000	Delco 1112684	55, 57, 79	1145A	91145A
All	4	Jet Star 3, 4 Star, 4 Star Super, 5 Star	Delco 1112642	55, 57, 79	1145A	91145A
All	4	U302 (206B-4, 220A4, 220-4 engine)	Delco	55, 57, 79	1145A	91145A
All	4	M670, U-302	Delco 1112642	55, 57, 79	1145A	91145A
All	4	M670, U-302	Delco 1112660	22, 57, 79	1146A	91146A
All	4	100, 101	Prestolite IAD-6004-2N	21, 55, 56, 57, 79	1541	91541
All	6	2890, 3490, 3496, 4290, 4292, 4293, 4296, 5297	Prestolite IAD-4040-1	56, 57, 79	1561	91561
All	6	G-704	Delco 1112662, 84	56, 57, 79	1163A	91163A
All	6	G-1000, G-1050, G-1350,	Delco	30, 56, 57, 79	1163A	91163A
MOTEC						
All	4	G-12	Prestolite IAD-6004-2F	21, 55, 56, 57, 79	1541	91541
All	4	M5	Prestolite IBT-4001G	55, 57, 79	1542	91542
MYERS						
All	1	6810 Wisconsin AGND engine	Prestolite	55, 56, 57, 79	1511	
All	1	4913 Series Wisconsin AHH engine	Autoilite	55, 56, 57, 79	1511	
All	1	5207 Series Wisconsin AKN engine	Autoilite	55, 56, 57, 79	1511	
All	1	6000 Series Wisconsin AENLD engine	Autoilite	55, 56, 57, 79	1511	
All	1	6013 Series Wisconsin AGN engine	Autoilite	55, 56, 57, 79	1511	
All	1	6125-F24 & R2 (Wisconsin AENLD engine)	Autoilite	55, 56, 57, 79	1511	
All	4	4920, 5035, 5050, 6035, 6040, 6050 Series (Wiscon)	Prestolite	55, 56, 57, 79	1541	91541
All	4	6100 Series Wisconsin VH4D engine	Prestolite	55, 56, 57, 79	1541	91541
All	4	6125-TF24, TR4 (Wisconsin VH4D engine)	Prestolite	55, 56, 57, 79	1541	91541
All	4	6125, 6E, 6T (Wisconsin VE4)	Prestolite	55, 56, 57, 79	1541	91541
All	4	6820 Wisconsin VH4D engine	Prestolite	55, 56, 57, 79	1541	91541
All	6	6060, 6095 Series (Chrysler 30 engine)	Prestolite	56, 57, 79	1561	91561
NEW HOLLAND						
All	4	87, 98, 99, 271, 280, 281, 290, 1281, 82	Prestolite IAD-6004	21, 55, 56, 57, 79	1541	91541
All	4	601, 611, 901, 905 (VG4D, VH4D, V460D, V461D)	Prestolite IAD-6004	21, 55, 56, 57, 79	1541	91541
All	4	600, 601, 611 Wisconsin VP4, VP4D engine	Autoilite IGW-4159A	55, 56, 57, 79	1545	91545
All	6	800, 810 Forage Harvester (Continental engine)	Prestolite IAD-6002-1G	56, 57, 79	1561	91561
OLIVER						
All	4	101, 102, 103, 620, 720 (VG4D, VH4D engine)	Prestolite IAD-6004	21, 55, 56, 57, 79	1541	91541
All	4	18 (Wisconsin VG4D, VH4)	Prestolite IAD-6004	21, 55, 56, 57, 79	1541	91541
All	4	36-02 (Wisconsin VE4, VE4D, VF4)	Prestolite	55, 56, 57, 79	1541	91541
All	4	36-32, 919 (Wisconsin VG4D)	Prestolite IAD-6004	21, 55, 56, 57, 79	1541	91541
All	4	125, T, EAP, EAPT, (Wisconsin)	Prestolite IAD series	29, 55, 56, 57, 79	1541	91541
All	4	919 Wisconsin VG4D	Prestolite	55, 56, 57, 79	1541	91541
All	4	10, 12, 14 & 16 Ft.	Prestolite IAD-6004	21, 55, 56, 57, 79	1541	91541
All	4	86, 96 (Wisconsin VG4D, VH4D)	Prestolite IAD-6004	21, 55, 56, 57, 79	1541	91541
All	4	85 (Wisconsin VE4, VE4D VF4)	Autoilite IGW-4159A	55, 56, 57, 79	1545	91545
All	4	125, T, EAP, EAPT, (Wisconsin)	Autoilite IGW series	55, 56, 57, 79	1545	91545
1964-65	6	248, 283, 310 Tractor	Holley	79	HO-161A	9HO-161A
All	6	33 (Continental F-226)	Prestolite	56, 57, 79	1561	91561
All	6	Edible Bean, 5542, 5555, (Chrysler engine)	Prestolite	56, 57, 79	1561	91561
All	6	430, 431, 525, 535, 542, 545 (Chrysler engine)	Prestolite IAD-4040-1	56, 57, 79	1561	91561
All	6	1600, 1800	Delco 1112632	56, 57, 79	1163A	91163A
OWATONNA						
All	4	25, 28, 30, 35, 60, 80, 81 (Wisconsin engine)	Prestolite IAD-6004-2F	21, 55, 56, 57, 79	1541	91541
All	4	90, 92, 1000, 1200, 1700 (Wisconsin engine)	Prestolite IAD-6004-2F	21, 55, 56, 57, 79	1541	91541
All	4	250, 350 Wisconsin VG4D engine	Prestolite	55, 56, 57, 79	1541	91541
All	6	700, 900 Chrysler 225 engine	Chrysler	79	1361A	91361A
REGAL AND ROCKOL						
All	6	B, C, E, ER, EW, HR, HW	Prestolite IAD series	56, 57, 79	1561	91561
WHITE FARM EQUIPMENT CO.						
All	4	U-302, Jet Star 3 (222A-4 gas & LPG engine)	Delco 1112642	55, 57, 79	1145A	91145A
All	4	550 Tractor	Delco 1112642	55, 57, 79	1145A	91145A
All	6	All	Delco 1112662, 684	56, 57, 79	1163A	91163A

FOOTNOTES

21	See page 56 for complete replacement distributors	29	Excluding distributor number IAD-4036	57	Ignitor version available in 12V positive ground, add P12 suffix
22	Clockwise rotation	30	Excluding distributor number 1112594	79	Not for use with solid core spark plug wires
24	Counter clockwise rotation	55	Ignitor version available in 6V negative ground, add N6 suffix		
28	Clip down cap	56	Ignitor version available in 6V positive ground, add P6 suffix		

AUTOMOTIVE BILLET DISTRIBUTORS

Plug n' Play billet distributors are designed for maximum ignition performance. Our distributors are available with advanced Ignitor III or Ignitor II technology. Replace your outdated points, or electronic distributor with this performance proven system. Simply install the distributor in the engine, connect two wires and start it up!

For even more performance, consider adding one of our compatible Flame-Thrower coils for increased spark energy and higher RPM potential. The lineup includes the Flame-Thrower II and Flame-Thrower III canister style coils as well as our HC and HV E-core style coils. Specific application information can be found in the coil section of this catalog. For a guide on our Plug n' Play billet distributor dimensions please see page 58.

FEATURES

- Precision CNC machined 6061-T6 billet aluminum housing is lightweight yet strong
- Each billet distributor is hand polished and buffed to a high luster
- Tempered distributor shaft has low torsion displacement for accurate timing and extended operational life
- Upper ball bearing and oil impregnated bronze lower bushing work together to reduce friction and provide shaft and advance mechanism stability reducing high RPM vibration
- 20CR Steel Gear Heat treated to surface hardness of 45C Rockwell
- Precision stamped and balanced mechanical advance weights eliminate erratic timing
- Adjustable mechanical advance with proprietary limiting function permits multiple settings. Distributors are factory set with a performance advance curve and are provided with additional springs for custom advance curves
- Premium high dielectric strength cap and rotor manufactured using PBT polymer and brass terminals
- Available with Ignitor II or Ignitor III integrated electronics
- Warranty: 30 Months electronics / Limited 1 year mechanical
- Legal in all 50 states and Canada. (C.A.R.B. E.O. #D-57-23)



Upper Ball Bearing

Ignitor II

FEATURES



- Patented technology with a powerful micro controller and adaptive dwell algorithms constantly adjust the dwell angle to maintain peak energy throughout the entire RPM range for increased high and low RPM performance.
- Cobalt magnets and Hall Effect trigger for stable timing and precise spark distribution.
- Adjusts spark timing at higher RPMs to compensate for the inherent electronic delay.
- Synchronized peak current and spark timing reduces heat build-up, increasing coil performance and module reliability.
- Built-in reverse polarity and over current protection shuts down the system, preventing component damage.
- Senses startup and increases energy for quicker, easier starting.
- Compatible with most Capacitive Discharge Systems.

Ignitor III

FEATURES



- Multiple sparks thru the entire RPM range.
- Integrated digital REV limiter with LED feedback for precise RPM setting.
- Memory safe function stores settings eliminating unintended changes to Rev limit.
- Adaptive dwell maintains peak energy throughout the entire RPM range, reducing misfires while improving engine performance.
- Peak current level is reached just prior to spark for maximum energy without heat build-up, increasing coil performance and module reliability.
- Adjusts spark timing at higher RPMs to compensate for the inherent electronic delay.
- Senses startup and increases energy for quicker, easier starting.
- Thermal clad surface mount construction for superior reliability.
- Built-in reverse polarity and over current protection shuts down the system, preventing component damage.
- Not compatible with CD or Multi-Spark boxes.



DESCRIPTION		FOOTNOTES	BLACK	RED	BLACK	RED
AMC ENGINES						
IGNITOR II EQUIPPED DISTRIBUTORS						
290-401	Vacuum advance distributor	79, 97, 99, 114	D160700	D160701	D160710	D160711
290-401	Non-Vacuum advance distributor	75, 79, 97, 99, 114	D160800	D160801	D160810	D160811
IGNITOR III EQUIPPED DISTRIBUTORS						
290-401	Vacuum advance distributor	79, 97, 100, 114	D7160700	D7160701	D7160710	D7160711
290-401	Non-Vacuum advance distributor	75, 79, 97, 100, 114	D7160800	D7160801	D7160810	D7160811
BUICK ENGINES						
IGNITOR II EQUIPPED DISTRIBUTORS						
194-292 L6	Vacuum advance distributor	79, 99, 114	D106700	D106701	D106710	D106711
194-292 L6	Non-Vacuum advance distributor	75, 79, 99, 114	D106800	D106801	D106810	D106811
215-350	Vacuum advance distributor	78, 79, 99, 114	D151700	D151701	D151710	D151711
215-350	Non-Vacuum advance distributor	75, 78, 79, 99, 114	D151800	D151801	D151810	D151811
400-455	Vacuum advance distributor	78, 79, 99, 114	D150700	D150701	D150710	D150711
400-455	Non-Vacuum advance distributor	75, 78, 79, 99, 114	D150800	D150801	D150810	D150811
IGNITOR III EQUIPPED DISTRIBUTORS						
215-350	Vacuum advance distributor	78, 79, 100, 114	D7151700	D7151701	D7151710	D7151711
215-350	Non-Vacuum advance distributor	75, 78, 79, 100, 114	D7151800	D7151801	D7151810	D7151811
400-455	Vacuum advance distributor	78, 79, 100, 114	D7150700	D7150701	D7150710	D7150711
400-455	Non-Vacuum advance distributor	75, 78, 79, 100, 114	D7150800	D7150801	D7150810	D7150811
CHEVROLET ENGINES						
IGNITOR II EQUIPPED DISTRIBUTORS						
194-292 L6	Vacuum advance distributor	79, 99, 114	D106700	D106701	D106710	D106711
194-292 L6	Non-Vacuum advance distributor	75, 79, 99, 114	D106800	D106801	D106810	D106811
90 V6	Vacuum advance distributor	48, 79, 89, 99, 104, 114	D107700	D107701	D107710	D107711
90 V6	Non-Vacuum advance distributor	48, 75, 79, 89, 99, 104, 114	D107800	D107801	D107810	D107811
SB-BB	Vacuum advance distributor	79, 89, 99, 114	D100700	D100701	D100710	D100711
SB-BB	Non-Vacuum advance distributor	75, 79, 89, 99, 114	D100800	D100801	D100810	D100811
SB-BB	Non-Vacuum advance distributor w/slip collar	75, 79, 87, 89, 99, 114	-----	-----	D105810	D105811
348-409	Vacuum advance distributor	79, 89, 99, 114	D101700	D101701	D101710	D101711
348-409	Non-Vacuum advance distributor	75, 79, 89, 99, 114	D101800	D101801	D101810	D101811
IGNITOR III EQUIPPED DISTRIBUTORS						
SB-BB	Vacuum advance distributor	79, 89, 100, 114	D7100700	D7100701	D7100710	D7100711
SB-BB	Non-Vacuum advance distributor	75, 79, 89, 100, 114	D7100800	D7100801	D7100810	D7100811
SB-BB	Non-Vacuum advance distributor w/slip collar	75, 79, 87, 89, 100, 114			D7105810	D7105811
348-409	Vacuum advance distributor	79, 89, 100, 114	D7101700	D7101701	D7101710	D7101711
348-409	Non-Vacuum advance distributor	75, 79, 89, 100, 114	D7101800	D7101801	D7101810	D7101811
CHRYSLER ENGINES						
IGNITOR II EQUIPPED DISTRIBUTORS						
273-360	Vacuum advance distributor	79, 99	D141700	D141701	D141710	D141711
273-360	Non-Vacuum advance distributor	75, 79, 99	D141800	D141801	D141810	D141811
383-400B	Vacuum advance distributor	73, 79, 99	D142700	D142701	D142710	D142711
383-400B	Non-Vacuum advance distributor	73, 79, 99	D142800	D142801	D142810	D142811
413-440RB	Vacuum advance distributor	73, 79, 99	D143700	D143701	D143710	D143711
413-440RB	Non-Vacuum advance distributor	73, 74, 75, 79, 99	D143800	D143801	D143810	D143811
426 Hemi	Vacuum advance distributor	79, 99	D143700	D143701	D143710	D143711
426 Hemi	Non-Vacuum advance distributor	75, 79, 99	D143800	D143801	D143810	D143811
IGNITOR III EQUIPPED DISTRIBUTORS						
273-360	Vacuum advance distributor	79, 100	D7141700	D7141701	D7141710	D7141711
273-360	Non-Vacuum advance distributor	75, 79, 100	D7141800	D7141801	D7141810	D7141811
383-400	Vacuum advance distributor	73, 79, 100	D7142700	D7142701	D7142710	D7142711
383-400	Non-Vacuum advance distributor	73, 75, 79, 100	D7142800	D7142801	D7142810	D7142811
413-440	Vacuum advance distributor	73, 79, 100	D7143700	D7143701	D7143710	D7143711
413-440	Non-Vacuum advance distributor	73, 75, 79, 100	D7143800	D7143801	D7143810	D7143811
426 Hemi	Vacuum advance distributor	79, 100	D7143700	D7143701	D7143710	D7143711
426 Hemi	Non-Vacuum advance distributor	75, 79, 100	D7143800	D7143801	D7143810	D7143811

FOOTNOTES

48 Even fire engine	78 Will not clear factory Grand Sport Ram Air air cleaner	99 Compatible with most CD boxes including Second Strike
73 Some cylinder head casting may need clearancing for distributor clearance	79 Not for use with solid core spark plug wires	100 Not Compatible with CD or multi-spark boxes
74 Will not Fit Wedge engines with aftermarket heads	87 Slip collar distributor allows adjustment of installed height for non standard deck engines	104 Carbureted applications only
75 For closed course competition use only, not to be used on emission controlled vehicles.	89 Bronze distributor gears available see page 46	114 20CR Steel gear, hardened to 45C Rockwell .5-.7mm depth
	97 Does not fit AMC 327cid engine	

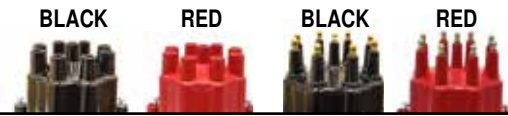

DESCRIPTION	FOOTNOTES	BLACK	RED	BLACK	RED
FORD ENGINES					
IGNITOR II EQUIPPED DISTRIBUTORS					
221-302 Vacuum advance distributor	79, 89, 99, 114	D130700	D130701	D130710	D130711
221-302 Non-Vacuum advance distributor	75, 79, 89, 99, 114	D130800	D130801	D130810	D130811
351W Vacuum advance distributor	79, 89, 99, 114	D131700	D131701	D131710	D131711
351W Non-Vacuum advance distributor	75, 79, 89, 99, 114	D131800	D131801	D131810	D131811
351C-460 Vacuum advance distributor	79, 89, 99, 114	D132700	D132701	D132710	D132711
351C-460 Non-Vacuum advance distributor	75, 79, 89, 99, 114	D132800	D132801	D132810	D132811
332-428 FE Vacuum advance distributor	79, 89, 99, 114	D133700	D133701	D133710	D133711
332-428 FE Non-Vacuum advance distributor	75, 79, 89, 99, 114	D133800	D133801	D133810	D133811
IGNITOR III EQUIPPED DISTRIBUTORS					
221-302 Vacuum advance distributor	79, 89, 100, 114	D7130700	D7130701	D7130710	D7130711
221-302 Non-Vacuum advance distributor	75, 79, 89, 100, 114	D7130800	D7130801	D7130810	D7130811
351W Vacuum advance distributor	79, 89, 100, 114	D7131700	D7131701	D7131710	D7131711
351W Non-Vacuum advance distributor	75, 79, 89, 100, 114	D7131800	D7131801	D7131810	D7131811
351C-460 Vacuum advance distributor	79, 89, 100, 114	D7132700	D7132701	D7132710	D7132711
351C-460 Non-Vacuum advance distributor	75, 79, 89, 100, 114	D7132800	D7132801	D7132810	D7132811
332-428 FE Vacuum advance distributor	79, 89, 100, 114	D7133700	D7133701	D7133710	D7133711
332-428 FE Non-Vacuum advance distributor	75, 79, 89, 100, 114	D7133800	D7133801	D7133810	D7133811

OLDSMOBILE ENGINES

IGNITOR II EQUIPPED DISTRIBUTORS					
194-292 L6 Vacuum advance distributor	79, 99, 114	D106700	D106701	D106710	D106711
194-292 L6 Non-Vacuum advance distributor	75, 79, 99, 114	D106800	D106801	D106810	D106811
260-455 Vacuum advance distributor	79, 99, 114	D110700	D110701	D110710	D110711
260-455 Non-Vacuum advance distributor	75, 79, 99, 114	D110800	D110801	D110810	D110811
IGNITOR III EQUIPPED DISTRIBUTORS					
260-455 Vacuum advance distributor	79, 100, 114	D7110700	D7110701	D7110710	D7110711
260-455 Non-Vacuum advance distributor	75, 79, 100, 114	D7110800	D7110801	D7110810	D7110811

PONTIAC ENGINES

IGNITOR II EQUIPPED DISTRIBUTORS					
194-292 L6 Vacuum advance distributor	79, 89, 99, 114	D106700	D106701	D106710	D106711
194-292 L6 Non-Vacuum advance distributor	75, 79, 89, 99, 114	D106800	D106801	D106810	D106811
301-455 Vacuum advance distributor	79, 89, 99, 114	D120700	D120701	D120710	D120711
301-455 Non-Vacuum advance distributor	75, 79, 89, 99, 114	D120800	D120801	D120810	D120811
IGNITOR III EQUIPPED DISTRIBUTORS					
301-455 Vacuum advance distributor	79, 89, 100, 114	D7120700	D7120701	D7120710	D7120711
301-455 Non-Vacuum advance distributor	75, 79, 89, 100, 114	D7120800	D7120801	D7120810	D7120811



Flame-Thrower Billet Distributors for VW Type I engines are available in several versions to satisfy any performance level. Our Ignitor equipped distributors provide huge improvements over points distributors and long term trouble free operation. Ignitor II distributors benefit from a integrated micro-controller for enhanced low and high RPM performance. The ultimate performance option for Type I engines is our Ignitor III billet distributor. Ignitor III distributors feature a built-in digital rev limiter and multiple sparks all the way to red line.



DESCRIPTION	FOOTNOTES	RED	BLACK	GREY
VW ENGINES				
Type I Ignitor equipped non-vacuum distributor	77, 79, 99, 121	-----	D186811	D186810
Type I Ignitor II equipped non-vacuum distributor	77, 79, 99, 121	-----	D180811	D180810
Type I Ignitor III equipped non-vacuum distributor	77, 79, 100, 121	-----	D7180811	D7180810

MARINE BILLET DISTRIBUTORS

Our marine Flame-Thrower billet distributors share many of the performance features that you find in our automotive distributors. Marine approved distributors are designed to meet or exceed SAE J1171 standards and are available with Ignitor II technology, or the Ignitor III multi-spark rev limiting modules. For even more performance, consider adding one of our compatible Flame-Thrower coils for increased spark energy and higher RPM potential. For a guide on our Plug n' Play Marine billet distributor dimensions please see page 58.

FEATURES

- Precision CNC machined 6061-T6 billet aluminum housing is lightweight yet strong
- Each billet distributor is hand polished and buffed to a high luster
- Tempered distributor shaft has low torsion displacement for accurate timing and extended operational life
- Upper ball bearing and oil impregnated bronze lower bushing work together to reduce friction and provide shaft and advance mechanism stability reducing high RPM vibration
- Precision stamped and balanced mechanical advance weights eliminate erratic timing
- Adjustable mechanical advance with proprietary limiting function permits multiple settings. Distributors are factory set with a performance advance curve and are provided with additional springs for custom advance curves
- Premium high dielectric strength cap and rotor manufactured using PBT polymer and brass terminals
- Available with Ignitor II or Ignitor III integrated electronics
- Triple screen spark arrester offers added protection
- Marine Approved SAE J1171 Certified
- Warranty: 30 Months electronics / Limited 1 year mechanical



DESCRIPTION	FOOTNOTES	BLACK	RED	BLACK	RED
CHEVROLET ENGINES					
90° V6 Ignitor II marine distributor	79, 89, 99, 114	D207800	-----	D207810	-----
SB-BB Ignitor II marine distributor	79, 89, 99, 114	D200800	D200801	D200810	D200811
SB-BB Ignitor II marine distributor reverse rotation engine	79, 99, 113, 114	D209800	D209801	-----	-----
SB-BB Ignitor III marine distributor	79, 89, 100, 114	D7200800	D7200801	-----	-----
SB-BB Ignitor III marine distributor reverse rotation engine	79, 100, 113, 114	D7209800	D7209801	-----	-----
CHRYSLER ENGINES					
273-360 Ignitor II marine distributor	79, 99	D241800	D241801	-----	-----
273-360 Ignitor III marine distributor	79, 100	D7241800	D7241801	-----	-----
FORD ENGINES					
221-302 Ignitor II marine distributor	79, 89, 99, 114	D230800	D230801	-----	-----
221-302 Ignitor III marine distributor	79, 89, 100, 114	D7230800	D7230801	-----	-----
351W Ignitor II marine distributor	79, 89, 99, 114	D231800	D231801	-----	-----
351W Ignitor III marine distributor	79, 89, 100, 114	D7231800	D7231801	-----	-----
351C-460 Ignitor II marine distributor	79, 89, 99, 114	D232800	D232801	-----	-----
351C-460 Ignitor III marine distributor	79, 89, 100, 114	D7232800	D7232801	-----	-----
OLDSMOBILE ENGINES					
260-455 Ignitor II marine distributor	79, 99, 114	D210800	D210801	-----	-----
260-455 Ignitor III marine distributor	79, 100, 114	D7210800	D7210801	-----	-----
GM ENGINES					
194-292 L6 Ignitor II marine distributor	79, 99, 114	D206800	-----	D206810	-----

FOOTNOTES

- | | |
|-----------------------------------------------------------------------------------------------------------------------------------------------------------------------------------------------------------------------------------------------------------------------------------------------------------------------------------------------------------------------------------------------------------------------------------------------------------------------------------------------------------------------------------------------------------|-------------------------------------------------------------------------------------------------------------------------------------------------------------------------------------------------------------------------------------------------------------------------------------------------------------------------------------------------------------------------------------------------------------------------------------------------------------------------------------------------------|
| <p>75 For closed course competition use only, not to be used on emission controlled vehicles.</p> <p>77 Distributor has male terminal distributor cap which requires different ignition wire terminals and boots</p> <p>79 Not for use with solid core spark plug wires</p> <p>89 Bronze distributor gears available see page 46</p> <p>99 Compatible with most CD boxes including Second Strike</p> <p>100 Not Compatible with CD or multi-spark boxes</p> <p>113 Distributor equipped with reverse cut gear for engines with non-standard rotation.</p> | <p>114 20CR Steel gear, hardened to 45C Rockwell. 5-.7mm depth</p> <p>121 This product is Legal for use on vehicles and is considered a "Replacement Part" per California Air Resources Board regulations as long as ALL emissions sensitive components are retained, including vacuum advance or retard devices. Failure to retain any of these components, would render this product ILLEGAL for Street or Off Highway use and may only be used for Closed Course Competition in all 50 states.</p> |
|-----------------------------------------------------------------------------------------------------------------------------------------------------------------------------------------------------------------------------------------------------------------------------------------------------------------------------------------------------------------------------------------------------------------------------------------------------------------------------------------------------------------------------------------------------------|-------------------------------------------------------------------------------------------------------------------------------------------------------------------------------------------------------------------------------------------------------------------------------------------------------------------------------------------------------------------------------------------------------------------------------------------------------------------------------------------------------|

MAGNETIC TRIGGER BILLET DISTRIBUTORS

Magnetic trigger billet distributors are an extension of the same great platform we designed for our Plug n' Play series distributors. These feature rich distributors are the perfect alternative to the over-priced distributors other competitors offer yet offer more value with precision engineered features including accurate signaling and superior dimensional stability. Our Magnetic trigger billet distributors feature vacuum advance canisters including optional lockout for ease of compatibility with your desired ignition system. Magnetic trigger billet distributors are the recommended choice when using the NEW **Digital HP** CD Ignition Box and Flame-Thrower HP Coil. For a guide on our Mag Trigger billet distributor dimensions please see page 58.

FEATURES

- Precision magnetic pickup coil and reluctor offer extremely accurate signaling at low and high RPM
- Specially engineered reluctor made from lightweight FC-0208 alloy offers superior dimensional stability for symmetrical spark separation
- Overmolded magnetic pickup coil supports windings while providing excellent resistance to corrosion
- Vacuum advance equipped with lockout provision included
- Easy wiring with standard Tyco Mate-N-Lok™ connector works with most ignition system harnesses
- Designed to be used with the PerTronix **Digital HP** Ignition system or other capacitive discharge boxes
- Limited One Year Warranty



Precision magnetic pickup coil and reluctor.



Upper Ball Bearing



BLACK

RED

DESCRIPTION	FOOTNOTES	BLACK	RED
AMC ENGINES			
NEW 215-350 Vacuum advance magnetic trigger distributor	81, 114	D360710	D360711
BUICK ENGINES			
NEW 215-350 Vacuum advance magnetic trigger distributor	81, 114	D351710	D351711
NEW 400-455 Vacuum advance magnetic trigger distributor	81, 114	D350710	D350711
CHEVROLET ENGINES			
SB/BB Non vacuum advance magnetic trigger distributor	75, 81, 89, 114	D300810	D300811
SB/BB Non vacuum advance magnetic trigger with slip collar	75, 81, 87, 89, 114	D305810	D305811
NEW SB/BB Vacuum advance magnetic trigger distributor with slip collar	81, 87, 89, 114	D305710	D305711
NEW SB/BB Vacuum advance magnetic trigger distributor	81, 89, 114	D300710	D300711
NEW 348-409 Vacuum advance magnetic trigger distributor	81, 89, 114	D301710	D301711
FORD ENGINES			
NEW 221-302 Vacuum advance magnetic trigger distributor	81, 89, 114	D330710	D330711
NEW 351W Vacuum advance magnetic trigger distributor	81, 89, 114	D331710	D331711
NEW 351C-429-460 Vacuum advance magnetic trigger distributor	81, 89, 114	D332710	D332711
NEW 332-428 FE Vacuum advance magnetic trigger distributor	81, 89, 114	D333710	D333711
MOPAR ENGINES			
NEW 273-360 Vacuum advance magnetic trigger distributor	81	D341710	D341711
NEW 383-400 Vacuum advance magnetic trigger distributor	81	D342710	D342711
NEW 426-440 Vacuum advance magnetic trigger distributor	81	D343710	D343711
OLDSMOBILE ENGINES			
NEW 260-455 Vacuum advance magnetic trigger distributor	81, 114	D310710	D310711
PONTIAC ENGINES			
NEW 301-455 Vacuum advance magnetic trigger distributor	81, 89, 114	D320710	D320711

FOOTNOTES

- 75 For closed course competition use only, not to be used on emission controlled vehicles. 87 Slip collar distributor allows adjustment of installed height for non standard deck engines 114 20CR Steel gear, hardened to 45C Rockwell .5-.7mm depth
- 81 Must be use with ignition box 89 Bronze distributor gears available see page 46



Flame-Thrower® IGNITION SYSTEM BUNDLES

Going to a complete PerTronix ignition system will improve your performance with more horsepower and better throttle response. PerTronix Ignition makes it easy including everything you need that has been engineered to perform at its best in one box. These bundles include a Flame-Thrower Billet Plug n' Play distributor with Ignitor II or Ignitor III module technology, a matching low resistance Flame-Thrower chrome coil topped off with a set of Flame-Thrower 8mm MAGx2 universal wires featuring silicone jackets to resist high temperatures. Bundles are available for the most popular Chevrolet and Ford engines as well as Chevrolet Marine.



ENGINE	DESCRIPTION	FEMALE BLACK CAP & WIRES	FEMALE RED CAP & WIRES	MALE BLACK CAP & WIRES	MALE RED CAP & WIRES
CHEVROLET ENGINES					
NEW SB/BB	Plug n' Play billet vacuum advance distributor with Ignitor II technology Flame-Thrower II Oil Filled Chrome Coil & 8MM 90° Universal Wires	Bundle001	Bundle002	Bundle010	Bundle005
NEW SB/BB	Plug n' Play billet vacuum advance distributor with Ignitor III technology Flame-Thrower III Oil Filled Chrome Coil & 8MM 90° Universal Wires	-----	-----	Bundle003	Bundle004
CHEVROLET MARINE ENGINES					
NEW SB/BB	Plug n' Play billet marine billet distributor with Ignitor II technology Flame-Thrower II Oil Filled Chrome Coil with Chrome Coil Bracket & 90° 8MM Wires	-----	Bundle501	-----	-----
FORD ENGINES					
NEW 221-302	Plug n' Play billet vacuum advance distributor with Ignitor II technology Flame-Thrower II Oil Filled Chrome Coil & Straight 8MM Universal Wires	Bundle006	Bundle007	Bundle011	-----
NEW 351W	Plug n' Play billet vacuum advance distributor with Ignitor II technology Flame-Thrower II Oil Filled Chrome Coil & Straight 8MM Universal Wires.	Bundle008	Bundle009	Bundle012	-----

Digital HP DIGITAL HP BUNDLES

The PerTronix **Digital HP** Bundle makes matching up the proper components for your application a snap, and with that you get everything you need at a value added bundled price. Each **Digital HP** Bundle includes one of our new **Digital HP** Ignition Boxes a 50,000 Volt HP Coil & a Plug n' Play billet magnetic trigger distributor. **Digital HP** Bundles are available for the most popular Chevrolet and Ford engines with your choice of a black or silver anodized finish.



ENGINE	DESCRIPTION	MALE BLACK CAP & BLACK DIGITAL HP	MALE BLACK CAP & SILVER DIGITAL HP
CHEVROLET ENGINES			
NEW SB/BB	Digital HP Ignition Box, 50,000 Volt HP Coil & Plug n' Play billet magnetic trigger distributor.	BundleHP01	BundleHP02
FORD ENGINES			
NEW 221-302	Digital HP Ignition Box, 50,000 Volt HP Coil & Plug n' Play billet magnetic trigger distributor.	BundleHP03	BundleHP04
NEW 351W	Digital HP Ignition Box, 50,000 Volt HP Coil & Plug n' Play billet magnetic trigger distributor.	BundleHP05	BundleHP06
NEW 352-428 FE	Digital HP Ignition Box, 50,000 Volt HP Coil & Plug n' Play billet magnetic trigger distributor.	BundleHP07	BundleHP08

BILLET DISTRIBUTOR PARTS & ACCESSORIES

Parts and accessories for Flame-Thrower Billet Distributors offer unmatched quality and accommodate the performance levels your distributor was engineered for.

DESCRIPTION	BLACK		RED	
	BLACK	RED	BLACK	RED
DISTRIBUTOR CAP AND ROTOR KITS				
Cap and rotor for 8 cylinder Flame-Thrower billet distributors	D600700	D600701	D600710	D600711
Cap and rotor for 6 cylinder Flame-Thrower billet distributors	D606700	D606701	-----	-----
Cap and rotor for 4 cylinder Flame-Thrower billet distributors	-----	-----	D604710	D604711
Cap and rotor for 4 cylinder Flame-Thrower billet distributors (Lt Grey Color)	-----	-----	D604713	-----
DISTRIBUTOR CAPS				
Replacement distributor cap for 8 cylinder automotive billet distributors	D650700	D650701	D650710	D650711
Replacement distributor cap for 8 cylinder marine billet distributors	D651700	D651701	D651710	D651711
Replacement distributor cap for 6 cylinder billet distributors	D656700	D656701	-----	-----
Replacement distributor cap for 4 cylinder billet distributors	-----	-----	D654710	D654711
Replacement distributor cap for 4 cylinder billet distributors (Lt Grey Color)	-----	-----	D654713	-----
DISTRIBUTOR ROTORS				
Replacement distributor rotor for all 6 & 8 cylinder billet distributors	D660701			
Replacement distributor rotor for all 4, cylinder VW billet distributors	D660707			



D654713



D651701



D600700



D7500702

MODULE KITS

- Replacement Ignitor II module for all billet distributors
- Replacement Ignitor module for D186810 and D186813 billet distributors
- Replacement Ignitor III module kit for clockwise rotating 8 cylinder billet distributors
- Replacement Ignitor III module kit for counter clockwise rotating 8 cylinder billet distributors
- Replacement Ignitor III module for D7180810 and D7180813 billet distributors

- D500700
- D500706
- D7500700
- D7500702
- D7500701



D500700

DISTRIBUTOR ADVANCE PARTS

- Vacuum canister for all automotive billet distributors
- Adjustable vacuum canister for all automotive billet distributors
- Vacuum lockout for all clockwise rotating automotive billet distributors
- Vacuum lockout for all counter clockwise rotating automotive billet distributors
- Mechanical advance spring kit with advance limiters

- D701700
- D909005
- D702700
- D703700
- D700700



D701700

DISTRIBUTOR GEARS

- Bronze gear Chevrolet 90° V6, SB, BB, 348-409 (0.5" shaft)
- Bronze gear Ford 289-302 (0.467" shaft)
- Bronze gear Ford 351W (0.5" shaft)
- Bronze gear Ford 351C, 351M, 400, 429 & 460 (0.5" shaft)
- Bronze gear Ford FE 352, 360, 390, 427, 428 (0.5" shaft)
- Bronze gear Pontiac 301-455 (0.5" shaft)

- D671001
- D671301
- D671302
- D671303
- D671303
- D671201



D671001

MARINE REVERSE CUT DISTRIBUTOR GEAR

Some marine applications are equipped with dual engines. These applications generally have one engine which rotates in the opposite direction and requires a specialized reverse cut distributor gear. Our high quality steel gears are designed specifically for marine Plug n' Play billet distributors and are precision ground to provide the perfect distributor to cam mesh Chevrolet 90° V6, SB and BB opposite rotation engines. (0.5" shaft)

- D671002



D700700

“STOCK-LOOK” DISTRIBUTORS

Flame-Thrower “Stock-Look” distributors are loaded with features that you would expect from a high performance part, yet maintain the original look for the ultimate “sleeper.” We build our distributors with all new components not remanufactured parts like the other guys. No need to hassle with adjusting points or replacing capacitors, because our distributors come equipped with maintenance free electronics providing decades of trouble free operation. Each distributor is complete with a high quality cap and rotor, so you’re ready to run right out of the box.

FEATURES

- All new lightweight cast aluminum housing
- High dielectric strength cap and rotor with brass contacts
- Optimized phasing insures maximum energy to the spark plug
- Tailored advance curve for optimal performance and drivability
- Integrated electronic ignition - available with Solid State Ignitor, the powerful Ignitor II with adaptive dwell control or Ignitor III with built in adjustable REV limiter and multi-spark through redline
- Legal in all 50 states and Canada (C.A.R.B. E.O. #D-57-23)
- Warranty: 30 months electronics / limited 1 year mechanical

THE CHOICE IS CLEAR!

	Flame-Thrower Stock-Look	Brand C
Distributor	New	Remanufactured
Cap and Rotor	New	Not Included
Trigger	Ignitor Electronics	Mechanical Points
Vacuum Advance	Adjustable	Fixed
Core Charge	None	\$10 & UP

IGNITOR®

FEATURES

- Delivers twice the voltage to the spark plugs, increasing horsepower, fuel economy, and spark plug life.
- 2:1 improvement over “points” in current fall time for increased coil output.
- *Rotating cobalt magnets trigger a Hall Effect integrated circuit ...no points to burn, ...no moving parts to wear out.
- Stable timing ...no need for any adjustments.
- Available for 12-volt and 6-volt negative ground systems.
- Will trigger most multi-spark CD ignitions.

* Some kits feature lobe sensing technology which does not utilize rotating magnets

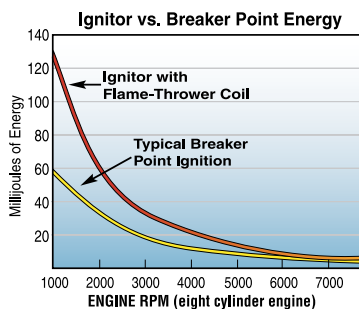

Ignitor II

FEATURES

- Integrated Ignitor II electronic ignition with variable dwell maintains peak energy throughout the entire RPM range, reducing misfires while improving engine performance.
- Develops on average 4 times more available energy between 3000 and 5000 RPM, and 2 times more available plug voltage.
- Peak current level is reached just prior to spark for maximum energy without the heat build-up, increasing coil and module life.
- Adjusts spark timing at higher RPMs to compensate for the inherent electronic delay.
- Senses startup and develops more energy for quicker, easier starting.
- Available for 12-volt negative ground systems.

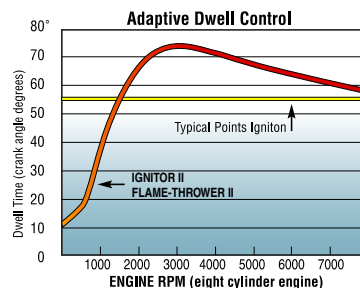

Ignitor III

FEATURES

- Multiple sparks thru the entire RPM range.
- Integrated digital REV limiter with LED feedback for precise RPM setting.
- Memory safe function stores settings eliminating unintended changes to Rev limit.
- Adaptive dwell maintains peak energy throughout the entire RPM range, reducing misfires while improving engine performance.
- Peak current level is reached just prior to spark for maximum energy without heat build-up, increasing coil performance and module reliability.
- Adjusts spark timing at higher RPMs to compensate for the inherent electronic delay.
- Senses startup and increases energy for quicker, easier starting.
- Thermal clad surface mount construction for superior reliability.
- Built-in reverse polarity and over current protection shuts down the system, preventing component damage.
- Not compatible with CD or Multi-Spark boxes.



CHEVROLET



FORD



CHRYSLER

These all new "Stock-Look" distributors are near exact duplicates of the original aluminum Delco distributors. Replace your worn out original distributors without compromising the original appearance of the engine. Our distributors are given a performance mechanical advance curve and adjustable vacuum advance for precise adjustments. Choose from Ignitor or Ignitor III electronic ignition.

No longer do you have to compromise the stock look of your engine for the sake of performance. Our distributors maintain the original Motorcraft look, but are loaded with performance features. Hidden under the cap is a powerful Ignitor or Ignitor III electronic ignition. Each distributor receives a performance advance curve and is equipped with an adjustable vacuum canister.

Just like the one from the factory.... only better! Starting with a replica of the original Chrysler 318 aluminum bodied distributors we have added features including a custom mechanical advance curve, adjustable vacuum canister and integrated Ignitor or Ignitor III electronics.

Description	Footnotes		
		Ignitor	Ignitor III
CHEVROLET ENGINES			
SB-BB Flame-Thrower "Stock Look" Delco style	79, 116	D104600	D7104600
CHRYSLER ENGINES			
273-360 Flame-Thrower "Stock Look" Chrysler style	79	D144600	D7144600
FORD ENGINES			
221-302 Flame-Thrower "Stock Look" Motorcraft style	79, 116	D134600	D7134600
351W Flame-Thrower "Stock Look" Motorcraft style	79, 116	D134610	D7134610
351C-460 Flame-Thrower "Stock Look" Motorcraft style	79, 116	D134620	D7134620
NEW 332-428 Flame-Thrower "Stock Look" Motorcraft style	79, 116	D134630	D7134630
REPLACEMENT MODULES			
Replacement module for "Stock-Look" Chevrolet distributor	79	D500715	D7500715
Replacement module for "Stock-Look" Chrysler distributor	79	D500718	D7500718
Replacement module for "Stock-Look" Ford distributor	79	D500716	D7500716

REPLACEMENT CAP & ROTOR KITS

- Chevrolet distributor cap and rotor D600702
- Chrysler distributor cap and rotor D600704
- Ford distributor cap and rotor D600703

ADJUSTABLE VACUUM CANISTER

- Chevrolet adjustable vacuum canister D909005
- Chrysler adjustable vacuum canister D909007
- Ford adjustable vacuum canister D909006



D600702



D600703

FOOTNOTES

79 Not for use with solid core spark plug wires
 116 Hardened steel gear, 45 Rockwell



ALFA ROMEO & VW



BRITISH 4 & 6

Our Bosch style "Stock-Look" distributors deliver excellent performance and won't break the bank. We've taken all the features that you like about the Bosch 009 distributor, and the performance of the 010 and 050 distributor and designed them into our distributors for a winning combination. Every distributor receives a custom tailored mechanical advance curve and is spin tested. Choose from our vacuum or non-vacuum advance versions. Available with integrated Ignitor, Ignitor II or the all new Ignitor III electronics.

Breath new life into your engine by replacing your tired old Lucas 23D, 25D or 45D distributor. These "Stock-Look" distributors for British 4 and 6 cylinder engines, ONLY look like original Lucas 25D or 45D parts. Under the distributor cap is a power packed Ignitor electronic ignition and custom advance curve. Each distributor is precision machined for an exact fit. Choose from a large selection of options to suit your particular engine and vehicle needs.



**ENGLISH FORD /
 LOTUS TWIN CAM**



ROVER V8



RENAULT R8

English Ford, Ford Crossflow & Lotus Twin cam engines don't have to use poor performing original Bosch, Lucas or Motorcraft distributors. Our "Stock-Look" distributors provide both style and performance. Using our 45D housings, we've designed several versions to suit just about any engine combination or driving type. Choose from vacuum advance or non-vacuum and side or top entry caps. Available with integrated Ignitor, Ignitor II or Ignitor III technology.

"Stock-Look" distributors for Rover V8 engines are perfect for popular V8 engine swaps. Made from all new castings and modeled after the original Lucas 35D distributor. Each distributor is precision machined for an exact fit. Available with integrated Ignitor, Ignitor II or Ignitor III electronic ignition. Stock replacement distributor with Rover OE style 35DLM two pin module is also available.

We've taken the impossible to find Ducellier distributor for Renault R8 engines and reproduced a high quality replica. These distributors have many performance features including an Ignitor electronic ignition for years of maintenance free operation.

Description	Polarity	Cap Style	Footnotes	Ignitor	Ignitor II	Ignitor III
ALFA ROMEO (1300, 1600, 1750 & 2.0 LITER) ENGINES						
Bosch style vacuum advance distributor	12V Neg	Top Exit	79, 107	D185504	D181504	D7181504
Bosch style non-vac. distributor	12V Neg	Top Exit	79, 107, 121	D185604	D181604	D7181604
BMC A+ ENGINE						
45D style vacuum advance distributor	12V Neg	Top Exit	79	D174118	D174218	D7174218
45D style vacuum advance distributor	12V Neg	Side Exit	79	D174119	D174219	D7174219
45D style non-vac. distributor	12V Neg	Top Exit	79, 121	D174128	D174228	D7174228
45D style non-vac. distributor	12V Neg	Side Exit	79, 121	D174129	D174229	D7174229
BMC A & B SERIES ENGINE						
23D style non-vac. advance distributor	12V Neg	Top Exit	79, 121	D173400	D173420	D7173420
23D style non-vac. advance distributor	12V Pos	Top Exit	121	D173401		
23D style non-vac. advance distributor	12V Neg	Side Exit	79, 121	D173409	D173429	D7173429
23D style non-vac. advance distributor	12V Pos	Side Exit	121	D173419		
25D style vacuum advance distributor	12V Neg	Top Exit	79	D172400	D172420	D7172420
25D style vacuum advance distributor	12V Neg	Side Exit	79	D172409	D172429	D7172429
25D style vacuum advance distributor	12V Pos	Top Exit	79	D172401		
25D style vacuum advance distributor	12V Pos	Side Exit	79	D172419		
45D style vacuum advance distributor	12V Neg	Top Exit	79	D176600	D170618	D7170618
45D style vacuum advance distributor	12V Neg	Side Exit	79	D176609	D170619	D7170619
45D style vacuum advance distributor	12V Pos	Top Exit	79	D178600		
45D style vacuum advance distributor	12V Pos	Side Exit	79	D178609		
45D style non-vac. advance distributor	12V Neg	Top Exit	79, 121	D176628	D170600	D7170600
45D style non-vac. advance distributor	12V Neg	Side Exit	79, 121	D176629	D170609	D7170609
BMC 6 CYLINDER ENGINE						
45D style vacuum advance distributor	12V Neg	Top Exit	79	D177600	D171618	
45D style vacuum advance distributor	12V Pos	Top Exit	79	D179600		
45D style non-vac. distributor	12V Neg	Top Exit	79, 121	D177628	D171600	
FORD 2.0L ENGINE						
Ford 2.0L vacuum advance distributor	12V Neg	Top Exit	79	D192400	D192420	D7192420
ENGLISH FORD & LOTUS TWIN CAM ENGINE						
45D style vacuum advance distributor	12V Neg	Top Exit	79, 115	D196600	D190600	D7190600
45D style vacuum advance distributor	12V Neg	Side Exit	79, 115	D196609	D190609	D7190609
45D style non-vac. advance distributor	12V Neg	Top Exit	79, 115, 121	D196500	D190500	D7190500
45D style non-vac. advance distributor	12V Neg	Side Exit	79, 115, 121	D196509	D190509	D7190509
ROVER V8 ENGINE						
35D8 style vacuum advance distributor	12V Neg	Top Exit	79, 105	D175510	D174510	
35DLM style distributor for 92-95 3.5L, 3.9L & 4.2L engines	12V Neg	Top Exit	79, 106	D175520		
RENAULT R8 ENGINE						
Ducellier style vacuum advance distributor 1964-78	12V Neg		79	D061601		
VW TYPE I ENGINES						
Bosch style vacuum advance distributor	12V Neg	Top Exit	79	D186504	D182504	D7182504
Bosch style vacuum advance distributor	6V Neg	Top Exit	79	D189504		
Bosch style non-vac. distributor	12V Neg	Top Exit	79, 121	D186604	D182604	D7182604
Bosch style non-vac. distributor	6V Neg	Top Exit	79, 121	D189604		

FOOTNOTES

79 Not for use with solid core spark plug wires

105 1976-Later Flex Shaft distributor

106 Stock replacement distributor with factory style 2 pin module

107 1956-81 Alfa Romeo 1300, 1600, 1750 and 2.0L engines

115 8620 Steel gear, hardened to 55-60C Rockwell .5-.7 mm depth

121 This product is legal for use on vehicles and is considered

a "Replacement Part" per California Air Resources Board regulations as long as ALL emissions sensitive components are

retained, including vacuum advance or retard devices. Failure to retain any of these components, would render this product ILLEGAL for Street or Off Highway use and may only be used for Closed Course Competition in all 50 states.



D500701

REPLACEMENT PARTS

Parts and accessories for Flame-Thrower Billet "Stock-Look" Distributors offer unmatched quality and accommodate the performance levels your distributor was engineered for.

	Ignitor	Ignitor II	Ignitor III
Module for Bosch style vacuum advance distributor	D500711	D500702	D7500701
Module for Bosch style vacuum advance distributor (6V neg)	D500712		
Module for Bosch style non-vac distributor	D500709	D500703	D7500701
Module for Bosch style non-vac distributor (6V neg)	D500710		
Module for 45D 4 cylinder distributor	D500707	D500701	D7500701
Module for 45D 6 cylinder distributor	D500707	D500701	
Module for 25D 4 cylinder distributor	D500717	D500705	D7500705
Module for 25D 4 cylinder distributor (12V pos)	D500719		
Module for 45D 4 & 6 cylinder distributor (12V pos)	D500708		
Module for 35D distributor	D500713	D500704	D7500704
Module for 35DLM OEM 2-pin	D500714		
Module for Ducellier style distributor	EP-1410		

REPLACEMENT MODULES

- Module for Bosch style vacuum advance distributor
- Module for Bosch style vacuum advance distributor (6V neg)
- Module for Bosch style non-vac distributor
- Module for Bosch style non-vac distributor (6V neg)
- Module for 45D 4 cylinder distributor
- Module for 45D 6 cylinder distributor
- Module for 25D 4 cylinder distributor
- Module for 25D 4 cylinder distributor (12V pos)
- Module for 45D 4 & 6 cylinder distributor (12V pos)
- Module for 35D distributor
- Module for 35DLM OEM 2-pin
- Module for Ducellier style distributor



D608600



D654609

CAPS & ROTORS

- | | |
|-------------------------------------------|---------|
| Bosch style Cap & rotor kit | D604604 |
| Bosch style Cap | D654604 |
| Bosch style Rotor | D660703 |
| 45D style 4 cyl top exit cap & rotor kit | D604600 |
| 45D style 4 cyl side exit cap & rotor kit | D604609 |
| 45D style 6 cyl top exit cap & rotor kit | D606600 |
| 45D style 4 cyl top exit cap | D654600 |
| 45D style 4 cyl side exit cap | D654609 |
| 45D style 6 cyl top exit cap | D656600 |
| 45D style 4 & 6 cyl rotor | D660702 |
| 23/25D style top exit cap & rotor kit | D604601 |
| 23/25D style side exit cap & rotor kit | D604610 |
| 23/25D style top exit cap | D654601 |
| 23/25D style side exit cap | D654610 |
| 23/25D style rotor | D660705 |
| 35D style cap and rotor kit | D608600 |
| 35D style cap | D658600 |
| 35D style rotor | D660704 |
| Ducellier style cap and rotor kit | D604606 |
| Ducellier style cap | D654606 |
| Ducellier style rotor | D660706 |

MAGNET SLEEVES

- | | |
|--------------------------------------------|---------|
| Magnet Sleeve for Billet Distributor | D660700 |
| Magnet Sleeve PTx 4 cyl British Cast Distr | D664600 |
| Magnet Sleeve 4 cyl VW Cast Distr | D664601 |
| Magnet Sleeve PTx 4cyl Billet Distr | D664700 |

MISC DISTRIBUTOR PARTS

- | | |
|------------------------------------|---------|
| Bosch style vacuum canister | D909003 |
| 45D style vacuum canister | D909004 |
| Crossflow / Lotus distributor gear | D909002 |

STREET / STRIP DISTRIBUTOR

Flame-Thrower Street / Strip distributors have a specially designed module and coil combination which operates without misfire beyond 7500 RPM. That's nearly 3000 RPM higher than most stock HEI distributors. Our distributors have a factory installed performance advance curve and feature an adjustable vacuum advance. Available with 6.9 amp performance module or our all new HEI III module. Legal in all 50 states and Canada (C.A.R.B. E.O. #D-57-23).

RACE ONLY DISTRIBUTOR

Race HEI distributors feature an electronic module and 50,000 volt coil combination that optimizes spark energy and peak current to the spark plug in the 6000 to 8500 RPM range. Each unit is TIG welded at critical points for improved reliability and to prevent high RPM distortion. Race HEI distributors are factory equipped with a specially designed vacuum advance lockout to prevent changes to rotor phasing and maximize combustion burn time. These distributors are not to be used on emission controlled vehicles, but are great for circle track or drag race applications where HEI distributors are mandated. Available with 7.2 amp "race only" module or our all new HEI III module.

FEATURES

- New lightweight aluminum alloy housing
- High dielectric strength cap with brass terminals and low resistance coil brush
- Balanced rotor with nylon screws prevent arcing and reduce vibration at high RPMs
- Precision machined chromoly advance weights and center plate eliminate erratic timing
- Additional advance springs included for fine tuning of the advance curve
- Bronze sintered bushings for reduced friction and extended life
- Centerless ground shaft reduces friction and provides concentric operation
- Distributor gear is ground to exact tolerances for tighter mesh with camshaft (Bronze distributor gear available)
- Meets stringent automobile susceptibility, vibration and shock requirements
- Limited One Year Warranty



HEI III MODULE



- Multiple sparks thru the entire RPM range.
- Integrated digital REV limiter with LED feedback for precise RPM setting.
- Adaptive dwell maintains peak energy throughout the entire RPM range, reducing misfires while improving engine performance.
- Peak current level is reached just prior to spark for maximum energy without the heat build-up, increasing coil performance and module reliability.
- Adjusts spark timing at higher RPMs to compensate for the inherent electronic delay.
- Senses startup and increases energy for quicker, easier starting.

PERFORMANCE MODULE



- Intended for street / strip applications
- 6.9 Amp module
- Matched module and coil combination
- 67% more energy with a 45% faster spark breakdown over stock HEI distributors.
- Enables larger plug gaps for increased flame kernel and more efficient combustion.

RACE ONLY MODULE



- Designed for racing applications
- 7.2 Amp Module
- Matched to 50,000 volt race only coil
- Optimized for 6000 to 8500 RPM range
- Produces 42% more energy with 46% faster spark breakdown over 6.9 Amp module.
- Double the spark intensity during the critical 1 ms burn time.



DESCRIPTION	FOOTNOTES			
CHEVROLET				
STREET / STRIP DISTRIBUTORS				
SB-BB Vacuum advance distributor with performance module	79, 116	D1000	D1001	D1002
SB-BB Vacuum advance distributor with HEI III module	79, 116	D71000	D71001	D71002
SB-BB Machine polished Vacuum advance distributor with performance module	79, 116	D1050	D1051	D1052
SB-BB Machine polished Vacuum advance distributor with HEI III module	79, 116	D71050	D71051	D71052
RACE ONLY DISTRIBUTORS				
SB-BB Non vacuum advance distributor with race only module	75, 79, 116	D1070	D1071	-----
SB-BB Non vacuum advance distributor with HEI III module	75, 79, 116	D71070	D71071	-----
STOCK REPLACEMENT SMALL CAP HEI DISTRIBUTORS				
SB-BB 1987-95 TPI/TBI equipped computer controlled cars and Trucks	79, 98, 116	D1020	D1021	-----
FORD				
STREET / STRIP DISTRIBUTORS				
289-302 Vacuum advance distributor with performance module	79, 116	D1350	-----	D1352
289-302 Vacuum advance distributor with HEI III module	79, 116	D71350	-----	D71352
RACE ONLY DISTRIBUTORS				
289-302 Non vacuum advance distributor with race only module	75, 79, 116	D1370	-----	D1372
289-302 Non vacuum advance distributor with HEI III module	75, 79, 116	D71370	-----	D71372
OLDSMOBILE				
STREET / STRIP DISTRIBUTORS				
260-455 Vacuum advance distributor with performance module	79, 116	D1100	D1101	D1102
260-455 Vacuum advance distributor with HEI III module	79, 116	D71100	D71101	D71102
RACE ONLY DISTRIBUTORS				
260-455 Non vacuum advance distributor with race only module	75, 79, 116	D1170	D1171	-----
260-455 Non vacuum advance distributor with HEI III module	75, 79, 116	D71170	D71171	-----
PONTIAC				
STREET / STRIP DISTRIBUTORS				
301-455 Vacuum advance distributor with performance module	79, 116	D1200	D1201	D1202
301-455 Vacuum advance distributor with HEI III module	79, 116	D71200	D71201	D71202
RACE ONLY DISTRIBUTORS				
301-455 Non vacuum advance distributor with race only module	75, 79, 116	D1270	-----	D1272
301-455 Non vacuum advance distributor with HEI III module	75, 79, 116	D71270	-----	D71272

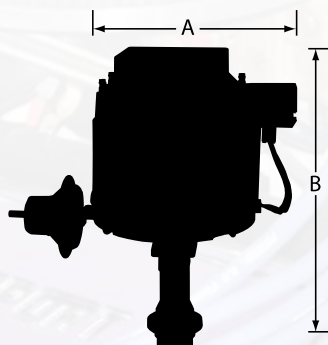

Flame-Thrower HEI distributors are dimensionally equivalent to the original Delco HEI distributors factory equipped in many 1975 and later applications. When using our HEI distributors in other applications, make sure to check critical areas for proper fit prior to installation. Air cleaners, alternators, firewalls and some intake manifolds can create problems in certain applications.

Description	Dim A	Dim B
Chevrolet small & big block engines	6.295"	7.5"
Chevrolet small & big block engines EST distributor	4.5"	7"
Ford 289-302 engines	6.295"	9.5"
Oldsmobile 260, 307, 330, 350, 400, 403, 425, 455	6.295"	8.5"
Pontiac 326, 350, 389, 400, 421, 428, 455	6.295"	9.1"

FOOTNOTES

75 For closed course competition use only, not to be used on emission controlled vehicles.
79 Not for use with solid core spark plug wires

98 Performance replacement distributor for 1987-95 GM TBI applications
116 Hardened steel gear, 45 Rockwell

PERFORMANCE TUNE-UP KITS

Everything you need to “wake up” your stock HEI distributor. Now available with our street/strip or HEI III ignition module. Performance tune-up kits include 4-pin module and coil combination, premium rotor and cap, embossed Flame-Thrower coil cover, adjustable vacuum advance canister, mechanical advance kit, wire harness and capacitor and complete installation hardware. “Race Only” tune-up kits bring HEI equipped circle track or drag race engines back to life. Available with “Race Only” or HEI III ignition module, matching 50,000 volt coil, wiring harness, vacuum lock out, advance weights, springs, bushings, cap, rotor, dust shield, and necessary hardware.



Description	Black	Red	Blue
Performance Tune-Up kit w/ Street/Strip module (red/yellow wire coil)	D8000	D8001	D8002
Performance Tune-Up kit w/ HEI III module (red/yellow wire coil)	D78000	D78001	D78002
Performance Tune-Up kit w/ Street/Strip module (red/white wire coil)	D8010	D8011	D8012
Performance Tune-Up kit w/ HEI III module (red/white wire coil)	D78010	D78011	D78012
Race Only Tune-Up Kit w/ short harness (Chevrolet)	D8070*	D8071*	
Race Only Tune-Up Kit with HEI III module w/ short harness (Chevrolet)	D78070*	D78071*	

For best results, match your original coil wire color to the proper Flame-Thrower coil.



Red/Yellow Wire



Red/White Wire

CAPS, ROTORS AND DUST COVERS

Made from hi-performance 60 KV rated alkyd molding compound for superior protection from “arc-thru” and cross-fire. Our cap and rotor kits include nylon rotor hold-down screws. Flame-Thrower dust covers provide a larger air gap around the coil which provides cooler operating temperatures.

Description	Black	Red	Blue
HEI distributor cap and rotor kits	D4000	D4001	D4002
HEI distributor cap	D4050	D4051	D4052
HEI distributor rotor		D4061	D4062
HEI dust cover with embossed Flame-Thrower script	D9000		
EST distributor cap (late model 87-95)	D4150	D4151	
EST distributor rotor (late model 87-95)	D4260		



DISTRIBUTOR COMPONENTS

From replacement wiring harness to adjustable vacuum advance canisters, lockout kits and mechanical advance kits, we have the parts to get your HEI distributor back into tip top condition.

Description	Part #
Wiring harness and capacitor - short (Chevrolet)	D9007
Adjustable vacuum advance canister	D9006
Clockwise vacuum lockout	D9010*
Counter clockwise vacuum lockout	D9011*
Mechanical advance curve kit. (Includes weights - center piece - springs - bushings)	D9001
Bronze distributor gear Chevrolet SB and BB engines 0.491 shaft	D6001

* For closed course competition use only, not to be used on emission controlled vehicles.

PERFORMANCE IGNITION MODULES

Our performance ignition modules are direct replacements for popular GM and Ford electronic distributors. These modules provide enhanced high RPM performance and when used with their corresponding Flame-Thrower coil, substantially increase spark plug voltage.

GM 4-PIN MODULE



- Intended for street / strip applications
- 6.9 Amp module
- 67% more energy with a 45% faster spark breakdown over stock HEI distributors.
- Enables larger plug gaps for increased flame kernel and more efficient combustion.
- Legal in all 50 states and Canada. (C.A.R.B. E.O. #D-57-22)

GM 4-PIN RACE MODULE



- Designed for racing applications
- 7.2 Amp Module
- Optimized for 6000 to 8500 RPM range
- Produces 42% more energy with 46% faster spark breakdown over 6.9 Amp module.
- Double the spark intensity during the critical 1 ms burn time.

HEI III MODULE



- Multiple sparks thru the entire RPM range.
- Integrated digital REV limiter with LED feedback for precise RPM setting.
- Adaptive dwell maintains peak energy throughout the entire RPM range, reducing misfires while improving engine performance.
- Peak current level is reached just prior to spark for maximum energy without the heat build-up, increasing coil performance and module reliability.
- Adjusts spark timing at higher RPMs to compensate for the inherent electronic delay.
- Senses startup and increases energy for quicker, easier starting.
- Legal in all 50 states and Canada. (C.A.R.B. E.O. #D-57-22)

GM 7-PIN MODULE



- Thick film technology on alumina ceramic substrates removes heat for greater accuracy and improved reliability.
- Laser trimming gives precise peak current control for increased energy output.
- Legal in all 50 states and Canada. (C.A.R.B. E.O. #D-57-22)
- Limited One Year Warranty.

GM 8-PIN MODULE



- Thick film technology on alumina ceramic substrates removes heat for greater accuracy and improved reliability.
- Laser trimming gives precise peak current control for increased energy output.
- Legal in all 50 states and Canada. (C.A.R.B. E.O. #D-57-22)
- Limited One Year Warranty.

FORD TFI MODULE



- Thick film technology on alumina ceramic substrates removes heat for greater accuracy and improved reliability.
- Laser trimming gives precise peak current control for increased energy output.
- Legal in all 50 states and Canada. (C.A.R.B. E.O. #D-57-22)
- Limited One Year Warranty.

Years	OEM Module Cross Reference	Amps	Coil	Module
GM 4-PIN MODULE				
1974-88	AC-Delco (D1906) American Motors (8131941) Delco (1875990 & 1894322)	6.9	D3000 - D3001	D2000
1974-88	AC-Delco (D1906) American Motors (8131941) Delco (1875990 & 1894322)	7.1	D3000, D3001, D3070	D72000
Universal	Developed for racing applications.	7.2	D3070	D2070
GM 7-PIN MODULE				
	AC-Delco (D1948, D1952, D1956, D1963A, D1968, D1973)			
1980-91	Delco (1988500, 1977907, 1978617, 1987714, 1976908)	4.0	D3000, D3001	D2001
GM 8-PIN MODULE				
	AC-Delco (D1978, D1979, D1990, D1993)			
1985-94	Delco (1987465, 1987466, 10469931, 10496048, 10496269, 10496541, 10496784, 6139369, 16139389, 16140039)	4.0	D3002	D2002
FORD TFI MODULE				
	Ford (E3EF-12A297-A1A, E3EF-12A297-A2A, E6EF-12A297-AA, E43Z-12A297-A E8FZ-12A297A)			
1983-93	Motorcraft (DY425)	4.0	D3003	D2010

INDUSTRIAL DISTRIBUTORS

PerTronix is the leading producer of electronic distributors for gas, propane and LP powered industrial engines. Many Wisconsin and Continental engines are equipped with our industrial distributors from the factory. Proven performance, reduced maintenance downtime, improved economy, faster starts and extended tune-up intervals. Our industrial distributors are also direct replacements for many point type Delco, and Prestolite distributors.



**NEVER
CHANGE
POINTS
AGAIN!**

FEATURES

- Durable yet lightweight housing
- Integrated Ignitor Electronic technology
- Superior venting system
- 'O' ring seal prevents oil leakage
- Precision engineered module switches 2 times more energy than other electronic ignition system
- Timing remains constant with an amazing 1/4° accuracy all the way down to zero RPM
- Effective RPM range of 0 to 6,000
- Non-tracking cap and rotor
- Warranty: 30 months Ignitor module / 90 days mechanical



Year	Cyl	Make / Model / Engine	Part No.
ALLIS CHALMERS			
1969-74	4	All models with clockwise distributor	D41-19A
CONTINENTAL			
All	3	TM-20 engine models	D33-03A
All	4	TM-27 engine models	D43-04B
1940-65*	4	F4 Series F124, F4124, F140, F4140, FA140 F162, F4162, FA162	D41-05A
1965-present	4	F4 Series F135, F163	D41-05A
1965-present	4	Y4 Series Y69, Y91, Y112, YA112, IY112, Y4069, Y4091, Y4112	D41-05A
1940-65*	6	F6 Series F170, F186, F209, F218, F224, F226, F244, F6170, F6186, F6209, F6226, F6244	D61-06A
1965-present	6	F6 Series F227, F245, F6227	D61-06A
All	4	R engine R08 models	D061601
All	4	CASE Skidsteer with Renault R688 Engine	D061701

* Distributors for 4 cylinder and 6 cylinder Continental engines replace the original Prestolite and/or Delco-Remy equipment in F4, F6 and Y4 series engines manufactured since 1965 and require no modifications. On engines prior to 1965 some modification and adaptation may be necessary. Consult installation instructions for details.

PERKINS			
1992 prior	4	G4236 engine	D41-20A
WAUKESHA			
1970-92	4	D155G, D176G, VRG220	D41-01A
WISCONSIN			
1955-present	1	Model BKN	D11-18A
1957-present	1	Model AENL	D11-18A
1968-present	2	Model TJD	D21-12A
1980-present	2	Model W2-1230, W2-1235	D21-11A
1980-present	2	Model W2-880	D21-12A
1987-present	2	Model W2-1250	D21-11A
1956-present	4	Model VH4D (side mount)	D41-09B
1956-present	4	Model VH4D (top mount)	D41-10B
1967-present	4	Model V65D (side mount)	D41-09B
1975-present	4	Model W4-1770 (top mount)	D41-10B
1976-present	4	Model W4-1770 (side mount)	D41-09B

INDUSTRIAL DISTRIBUTOR CROSS REFERENCE

Original Dist. No.	PerTronix Dist. No.
CLARK	
1636495.....	D41-01A
2372353.....	D41-01A
914528.....	D43-04B
COLT	
FMD1C7.....	D11-18A
FMD2C7.....	D21-12A
FMD2C7-B.....	D21-11A
FMD4C7.....	D41-09B
FMD427A.....	D41-10B
CONTINENTAL	
F162M-00232.....	D41-05A
F162M-00311.....	D41-05A
F162M-00315.....	D41-05A
F162M-00347.....	D41-05A
F162M-00412.....	D41-05A
F162M-00446.....	D41-05A
F162M-00462.....	D41-05A
F162M-00466.....	D41-05A
F186M-00202.....	D61-06A
F226M-00304.....	D61-06A
F226M-00309.....	D61-06A
F226M-00404.....	D61-06A
F226M-00407.....	D61-06A
F226M-00416.....	D61-06A
F226M-00421.....	D61-06A
F226M-00424.....	D61-06A
F226M-00433.....	D61-06A
F226M-00436.....	D61-06A
F244M-00406.....	D61-06A
F244M-00414.....	D61-06A
F244M-00523.....	D61-06A
F226M-00503.....	D61-06A
F400M-00305.....	D41-05A
F400M-00307.....	D41-05A
F400M-00392.....	D41-05A
F400M-00533.....	D41-05A
F400M-00411.....	D41-05A
F400M-00413.....	D41-05A
F400M-00449.....	D41-05A
F400M-00466.....	D41-05A
F400M-00472.....	D41-05A
F400M-00503.....	D41-05A
F400M-00507.....	D41-05A
F400M-00516.....	D41-05A
F400M-00518.....	D41-05A
F400M-00521.....	D41-05A
F400M-00531.....	D41-05A
F400M-00532.....	D41-05A
F401M-00405.....	D41-05A
F401M-00406.....	D41-05A
F600M-00305.....	D61-06A
F600M-00314.....	D61-06A
F600M-00373.....	D61-06A
F600M-00380.....	D61-06A
F600M-00405.....	D61-06A
F600M-00439.....	D61-06A
F600M-00440.....	D61-06A
F600M-00449.....	D61-06A
F600M-00451.....	D61-06A
F600M-00502.....	D61-06A
F600M-00508.....	D61-06A

Original Dist. No.	PerTronix Dist. No.
F600M-00509.....	D61-06A
CONTINENTAL	
F600M-00510.....	D61-06A
F600M-00518.....	D61-06A
F600M-00519.....	D61-06A
F600M-00525.....	D61-06A
TM13M-00501.....	D23-02A
TM20M-00500.....	D33-03A
TM20M-00501.....	D33-03A
TM20M-00503.....	D33-03AM
TM27M-00502.....	D43-04B
TM27M-00503.....	D43-04B
TM27M-00510.....	D43-04B
TM27M-00511.....	D43-04BM
Y112M-00237.....	D41-05A
Y112M-00305.....	D41-05A
Y112M-00500.....	D41-05A
Y400M-00281.....	D41-05A
Y112M-00311.....	D41-05A
Y91M-00411.....	D41-05A
DELCO	
1110021.....	D61-06A
1110305.....	D61-06A
1110306.....	D41-05A
1110402.....	D41-05A
1110420, 23.....	D41-05A
1111310.....	D61-05A
1111356.....	D41-05A
1111428.....	D41-05A
1111429.....	D61-06A
1111432.....	D41-05A
1111576.....	D41-05A
1111620.....	D61-06A
1111700.....	D41-01A
1111716, 17.....	D41-05A
1111728.....	D61-06A
1111769.....	D61-12A
1111870.....	D61-12A
1111895.....	D61-06A
1111913.....	D61-06A
1112461.....	D61-19B
1112508.....	D61-06A
1112552.....	D61-06A
1112567.....	D61-06A
1112604.....	D41-05A
1112628.....	D61-06A
1112637.....	D41-05A
1112672.....	D61-06A
1112673.....	D41-05A
1112685.....	D41-01A
1112789.....	D41-05A
DUCELLIER	
R287D83.....	D061601
R296C52.....	D061701
MALLORY	
YL-664A.....	D41-01A
PRESTOLITE	
IAD-4029, A.....	D41-05A
IAD-4033.....	D61-06A
IAD-6002-1F.....	D61-06A
IAD-6003-2H.....	D41-05A
IAD-6004-1E.....	D41-05A

Original Dist. No.	PerTronix Dist. No.
PRESTOLITE (CONT)	
IAD-6004-2F, N.....	D41-09B
IAD-6004-2P.....	D41-10B
IAD-6006-1.....	D61-06A
IBT-4101H.....	D41-05A
IBT-4105A.....	D41-01A
IBT-4105B.....	D41-05A
IBT-4106, E.....	D41-27A
IBT-4106A.....	D41-28A
IBT-4106B, C, D.....	D41-26A
IBT-4201.....	D21-11A
IBT-4705.....	D41-05A
IBT-4706.....	D41-05A
IBT-6501D.....	D61-06A
IBT-6702, 03.....	D61-06A
IDJ-4008.....	D41-05A
IDJ-4012.....	D41-05A
IDJ-4013, 14.....	D61-06A
IDN-4012.....	D43-04B
IDN-4014.....	D33-03A
IDU-4403A, B.....	D41-01A
IDU-4406, 08.....	D41-20A
IGB-4045A.....	D41-05A
IGB-4304B.....	D61-06A
IGC-4722.....	D61-06A
IGC-6004-1.....	D41-05A
IGW-4139, C.....	D41-05A
IGW-4156A.....	D41-05A
IGW-4408.....	D11-18A
IGW-4412.....	D21-12A
IGW-6581B.....	D41-05A
WAUKESHA	
60262K.....	D41-01A
69748A.....	D41-01A
WISCONSIN	
YF-10C.....	D41-09B
YF-10D.....	D41-10B
YF-35.....	D21-12A
YF-40.....	D21-12A
YF-42.....	D21-11A
YF-45.....	D41-09B
YF-45A.....	D41-10B
YF-46.....	D21-12A
YF-48.....	D21-11A
YF-49.....	D11-18A
YF-50, YF-50C.....	D41-09B
YF-50A, YF-50D.....	D41-10B
YF-50B, YF-50E.....	D41-11B
YF-51, YF-51A.....	D21-11A
YF-52, YF-52A.....	D21-12A
YF-53.....	D11-18A
YF-54, YF-54A.....	D21-13A
YF-8C.....	D11-18A

SERVICE PARTS

Keep that engine in your hard working equipment running strong by using high quality service parts from PerTronix. We have a complete selection of service parts to fit our industrial distributors. These parts can also be used to service many original equipment distributors found in Wisconsin and Continental engines.



Dist. Number	Cap	Rotor	Cap Gasket	Dust Cover	Magnet Sleeve	Module	Drive	Advance Spring	Advance Weight	Vac. Advance
D11-18A	022-1101	N/A	027-001	N/A	026-101	025-004B	N/A	N/A	019-1001	N/A
D21-11A	022-1203	020-1002	027-001	021-001	026-202	025-005B	023-1002	018-1005	019-1003	N/A
D21-12A	022-1202	020-1002	027-001	021-001	026-201	025-004B	023-1003	018-1004	019-1001	N/A
D21-13A	022-1204	020-1002	027-001	021-001	026-203	025-004B	023-1003	018-1004	N/A	N/A
D23-02A	022-1201	020-1001	027-002	021-001	026-201	025-002B	023-1001	018-1001	019-1001	N/A
D33-03A	022-1301	020-1001	027-002	021-001	026-301	025-002B	023-1001	018-1001	019-1001	024-001
D33-03AM	022-1301	020-1001	027-002	021-001	026-301	025-006B	023-1001	018-1001	019-1001	N/A
D41-01A	022-1403	020-1003	027-001	021-001	026-401	025-008A	023-1004	018-1007	019-1003	N/A
D41-05A	022-1403	020-1003	027-001	021-001	026-401	025-003A	023-1005	018-1002	019-1001	N/A
D41-09B	022-1403	020-1002	027-001	021-001	026-401	025-003A	023-1002	018-1003	019-1001	N/A
D41-10B	022-1403	020-1002	027-001	021-001	026-401	025-003A	023-1002	018-1003	019-1001	N/A
D41-11B	022-1403	020-1002	027-001	021-001	026-401	025-003A	023-1012	018-1003	019-1001	N/A
D41-19A	022-1403	020-1003	027-001	021-001	026-401	025-007A	023-1006	018-1008	019-1003	N/A
D41-20A	022-1403	020-1003	027-001	021-001	026-401	025-003A	023-1007	018-1009	019-1001	N/A
D43-04B	022-1404	020-1001	027-002	021-001	026-401	025-001A	023-1001	018-1001	019-1001	024-001
D61-06A	022-1602	020-1003	027-001	021-001	026-601	025-003A	023-1005	018-1002	019-1001	N/A
D61-19B	022-1602	020-1003	027-001	021-001	026-601	025-007A	N/A	018-1008	019-1003	N/A

INDUSTRIAL DISTRIBUTOR DIMENSIONS

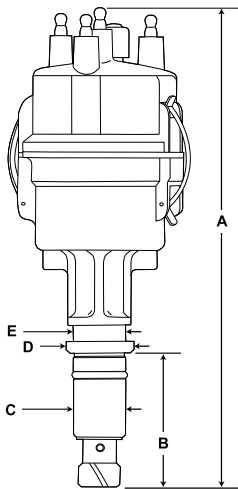

Distributor Number	Dim. A	Dim. B	Dim. C	Dim. D	Dim. E	Drive	Rotation
D11-18A	6.30	2.67	1.06	----	----	----	CCW
D21-11A	8.29	2.85	1.06	----	----	GEAR	CW
D21-12A	7.88	2.46	1.06	----	----	GEAR	CCW
D23-02A	9.21	2.71	1.06	1.36	1.05	GEAR	CCW
D33-03A	9.51	2.71	1.06	1.36	1.05	GEAR	CCW
D33-03AM	9.51	2.71	1.06	1.36	1.05	GEAR	CCW
D41-01A	8.55	2.34	1.06	1.60	1.12	TANG	CW
D41-05A	7.58	1.31	1.06	1.36	1.05	TANG	CCW
D41-09B	7.88	2.62	1.06	----	----	GEAR	CCW
D41-10B	7.88	2.66	1.06	----	----	GEAR	CCW
D41-19A	8.80	2.53	1.06	1.60	1.12	TANG	CW
D41-20A	8.25	2.13	1.06	1.69	1.05	GEAR	CCW
D41-26A	8.25	2.13	1.06	1.69	1.05	GEAR	CCW
D41-27A	8.25	2.13	1.06	1.69	1.05	GEAR	CCW
D41-28A	8.25	2.13	1.06	1.69	1.05	GEAR	CCW
D43-04B	9.21	2.71	1.06	1.36	1.05	GEAR	CCW
D61-06A	7.64	1.31	1.06	1.36	1.05	TANG	CCW
D61-12A	7.64	1.31	1.06	1.36	1.05	TANG	CCW
D61-19B	7.64	1.31	1.06	1.36	1.05	TANG	CCW

BILLET DISTRIBUTOR DIMENSIONS

Flame-Thrower billet distributors are frequently used in tight engine compartments due to their simple design and relatively small size. The chart below details approximate distributor dimensions for each engine family. The height dimension "A" is taken from the installed surface to the highest point on the distributor cap. Although our distributors fit their intended engine application, each vehicle application must be evaluated independently to insure adequate space for distributor fitment as well as air cleaner and hood clearance.

Description	Female Cap		Male Cap	Gear I.D.
	Dim A	Dim B	Dim B	
AMC engines	5"	8.52"	9.24"	0.5"
Buick engines	5"	8.29"	8.92"	0.5"
Ford 289-302 engines	5"	7.77"	8.49"	0.467"
Ford 351W & 351C-460 engines	5"	8.60"	9.32"	0.5"
Ford 332-428 FE engines	5"	8.41"	9.13"	0.5"
Chevrolet small & big block engines	5"	7.66"	8.38"	0.5"
Chevrolet 348-409 engines	5"	7.26"	7.98"	0.5"
Chevrolet 90 degree V6 engines	5"	7.66"	N/A	0.5"
Chrysler 273, 318, 340 & 360 engines	5"	7.82"	8.54"	N/A
Chrysler 383-400 & 413-440 engines	5"	7.80"	8.52"	N/A
Chrysler 426 Hemi engines	5"	7.80"	8.52"	N/A
GM L6 engines	5"	7.66"	N/A	0.486"
Oldsmobile 260-455 engines	5"	8.64"	9.36"	0.5"
Pontiac 301-455 engines	5"	8.39"	9.11"	0.5"
Volkswagen Type I engines	4.625"	N/A	5.5"	0.5"

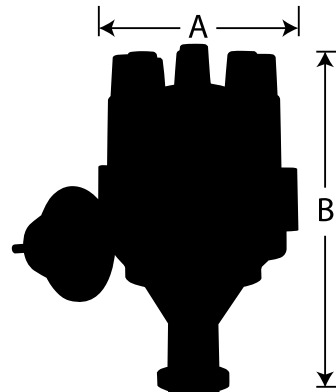

Flame-Thrower®

40,000 VOLT CANISTER COILS

While it's the perfect coil to go with the PerTronix Ignitor breakerless ignition, our 40,000 volt Flame-Thrower canister coil can benefit virtually any distributor type inductive system. Its higher voltage allows larger spark plug gaps for added power, smoother response and better fuel economy. These coils are internally resisted so installation and wiring is drastically simplified. Our oil filled coils offer great heat control for street driven vehicles, while our epoxy filled coils provide superior winding support for high vibration environments in off-road vehicles and boats.

FEATURES

- 40,000 volts.
- Available chrome plated or black for that "stock look"
- For use with inductive ignition systems
- 1.5 or 3.0 Ohm primary resistance values available
- Legal in all 50 states and Canada (C.A.R.B. E.O. #D-57-21)
- Limited 90 Day Warranty

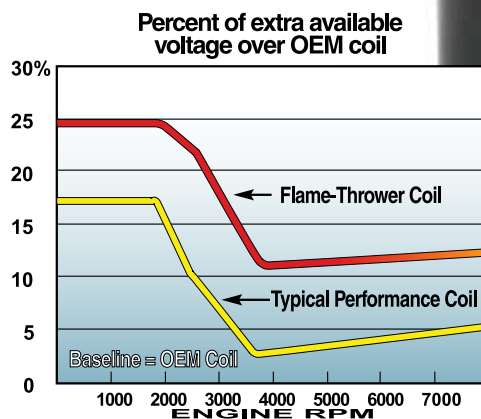

Eight cylinder engine with PerTronix Ignitor installed.



Flame-Thrower® II

45,000 VOLT CANISTER COILS

Flame-Thrower II coils feature a very low resistance which make them the ideal coil for Ignitor II ignition systems as well as many other high performance ignitions. Low resistance and improved turns ratio help to produce up to 45,000 volts. This higher voltage enables you to run larger spark plug gaps for added power and better fuel economy. These coils are also compatible with most capacitive discharge boxes including our own Second Strike.

FEATURES

- 45,000 volts
- Available chrome plated or black for that "stock look"
- For use with inductive or CD ignition systems
- Low 0.6 Ohm primary resistance
- Legal in all 50 states and Canada (C.A.R.B. E.O. #D-57-21)
- Limited 90 Day Warranty

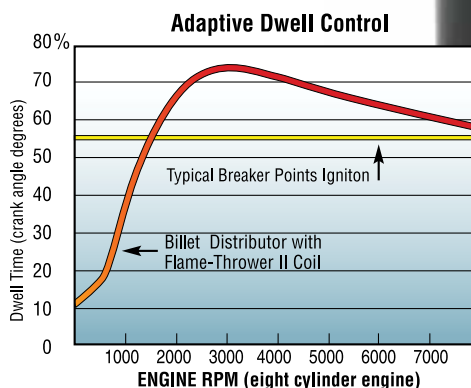

Flame-Thrower III

45,000 VOLT CANISTER COILS

Flame-Thrower III coils feature an ultra low resistance and are designed specifically for the Ignitor III ignition system. Flame Thrower III coils have a high turns ratio and ultra low primary resistance enabling the ignition system to charge faster at high RPM's.

FEATURES

- 45,000 volts
- Ultra Low 0.32 primary resistance
- Compatible with Ignitor III systems as well as most capacitive discharge systems
- Charges to peak current typically 30-70% faster than other coils
- Rapid charge time means maximum spark energy is sustained to higher engine RPM
- Legal in all 50 states and Canada (C.A.R.B. E.O. #D-57-21)
- Limited 90 Day Warranty

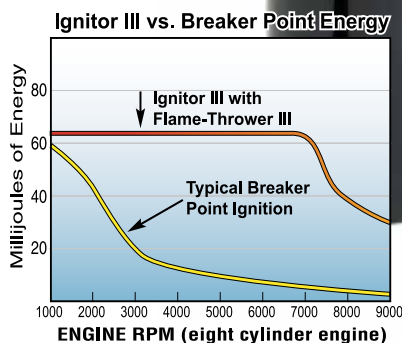

APPLICATION CHART

Ignition Type	System Voltage	Resistance	Application	28,000 Volts	40,000 Volts	45,000 Volts
IGNITOR or points	12V	3 Ω	4 & 6 cylinder engines	28010	40501, 40511 40611	
	12V	1.5 Ω	8 cylinder engine		40001, 40011 40111	
	6V	1.5 Ω	4 & 6 cylinder engines		40001, 40011 40111	
	6V	0.6 Ω	8 cylinder engines			45001, 45011 45111
Ignitor II	12V	0.6 Ω	4, 6 and 8 cylinder engines			45001, 45011 45111
Ignitor III	12V	0.32 Ω	4, 6 and 8 cylinder engines			44001, 44011

Note: Shaded area of application chart applies to positive ground as well as negative ground applications.

Part No.	Description	Finish	Turn Ratio	Primary Resistance	Secondary Resistance	Primary Inductance	Maximum Voltage	Height	Diameter
FLAME-THROWER 40,000 VOLT COILS									
40001	Flame-Thrower Oil Filled	Chrome	100:1	1.5 Ohms	9.0k Ohms	6.4mH	40,000	6.0"	2.15"
40011	Flame-Thrower Oil Filled	Black	100:1	1.5 Ohms	9.0k Ohms	6.4mH	40,000	6.0"	2.15"
40501	Flame-Thrower Oil Filled	Chrome	80:1	3.0 Ohms	9.0k Ohms	10.0mH	40,000	6.0"	2.15"
40511	Flame-Thrower Oil Filled	Black	80:1	3.0 Ohms	9.0k Ohms	10.0mH	40,000	6.0"	2.15"
40111	Flame-Thrower Epoxy Filled	Black	100:1	1.5 Ohms	9.0k Ohms	6.4mH	40,000	6.0"	2.15"
NEW 40601	Flame-Thrower Epoxy Filled	Chrome	80:1	3.0 Ohms	8.5k Ohms	10.0mH	40,000	6.0"	2.15"
40611	Flame-Thrower Epoxy Filled	Black	80:1	3.0 Ohms	8.5k Ohms	10.0mH	40,000	6.0"	2.15"
FLAME-THROWER II 45,000 VOLT COILS									
45001	Flame-Thrower II Oil Filled	Chrome	100:1	0.6 Ohms	9.0k Ohms	6.0mH	45,000	6.0"	2.15"
45011	Flame-Thrower II Oil Filled	Black	100:1	0.6 Ohms	9.0k Ohms	6.0mH	45,000	6.0"	2.15"
45111	Flame-Thrower II Epoxy Filled	Black	100:1	0.6 Ohms	9.0k Ohms	6.0mH	45,000	6.0"	2.15"
FLAME-THROWER III 45,000 VOLT HIGH CURRENT COILS									
44001	Flame-Thrower III Oil Filled	Chrome	110:1	0.32 Ohms	7.0k Ohms	2.5mH	45,000	6.0"	2.15"
44011	Flame-Thrower III Oil Filled	Black	110:1	0.32 Ohms	7.0k Ohms	2.5mH	45,000	6.0"	2.15"
SPECIALITY INDUSTRIAL COIL									
28010	Oil Filled	Black	50:1					6.0"	2.15"
UNIVERSAL COIL BRACKETS									
10001	Coil bracket	Zinc							
10002	Coil bracket	Chrome							

Flame-Thrower **HP**

50,000 VOLT COIL

HP (HIGH POWER) E-core coils were specifically designed for use with the PerTronix Digital HP Ignition. The larger epoxy encapsulated coil body, more substantial steel E-core, and 6063 T5 aluminum heat sink, enable it to meet the demands of high RPM CD systems. Extended primary terminal spacing and added secondary terminal shielding prevent potentially damaging spark arc-over.

Flame-Thrower **HC**

60,000 VOLT COIL

HC (HIGH CURRENT) E-core coils are engineered specifically for our Ignitor III ignition modules. HC coils have a high turns ratio and ultra low primary resistance enabling the ignition system to charge faster at high RPM's. The coil is supported in a special heat sink made from aircraft 6063 T5 aluminum which efficiently transfers heat away from the windings.

Flame-Thrower **HV**

60,000 VOLT COIL

Our HV (HIGH VOLTAGE) E-core design yields an incredible 60,000 volts and operates with no degradation throughout temperature ranges that surpass military specifications. The special heat sink design made from aircraft 6063 T5 aluminum efficiently transfers heat optimizing energy output for street/strip and off road applications. Flame-Thrower HV .45 ohm coils are also compatible with most capacitive discharge boxes including our own Second Strike.

NEW



FEATURES

- 50,000 - 60,000 volts
- Highly efficient E-core design
- Vacuum potted body for longer life and increased reliability
- 6063 T5 aluminum heat sink with black anodized corrosion resistant finish
- Precision machined male high tension terminal and brass primary terminals
- Legal in all 50 states and Canada (C.A.R.B. E.O. #D-57-21)
- Limited 90 Day Warranty

APPLICATION CHART

Ignition Type	Application	Part No.
IGNITOR or points	4 & 6 cylinder engines	60130
	8 cylinder engine	60115
Ignitor II	4, 6 and 8 cylinder engines	60104
Ignitor III	4, 6 and 8 cylinder engines	60103

Note: Shaded area of application chart applies to positive ground as well as negative ground applications.

Part No.	Description	Finish	Turn Ratio	Primary Resistance	Secondary Resistance	Primary Inductance	Maximum Voltage	Length	Width	Height
50,000 VOLT HP COILS										
NEW 60100	HP Epoxy Filled E-core design	Black	100:1	0.2 Ohms	1.38k Ohms	7.0mH	50,000	4.0"	4.75"	3.75"
60,000 VOLT HV COILS										
60104	HV Epoxy Filled E-core design	Black	90:1	0.45 Ohms	7.3k Ohms	3.8mH	60,000	4.6"	4.65"	3.15"
60115	HV Epoxy Filled E-core design	Black	85:1	1.5 Ohms	14.0k Ohms	6.4mH	60,000	4.6"	4.65"	3.15"
60130	HV Epoxy Filled E-core design	Black	85:1	3.0 Ohms	22.8k Ohms	9.0mH	60,000	4.6"	4.65"	3.15"
60,000 VOLT HC COILS										
60103	HC Epoxy Filled E-core design	Black	110:1	0.32 Ohms	7.0k Ohms	2.5mH	60,000	4.6"	4.65"	3.15"

50,000 VOLT E-CORE COILS

Flame-Thrower E-Core coils feature optimized winding design to maximize spark gap current and available voltage. When teamed with Flame-Thrower ignition modules they produce 100% more energy across the spark plug gap (during a one millisecond burn time) compared to the OEM coil. Select one of our matching Flame-Thrower ignition modules on page 55 for a performance proven combo.



FEATURES

- 50,000 volts
- Ultra low primary resistance values
- Limited 90 Day Warranty
- Legal in all 50 states and Canada (C.A.R.B. E.O. #D-57-21)

GM HEI COIL (YELLOW WIRE)



D3000

Replaces internal GM coils with black, yellow and red wires.



GM HEI COIL (WHITE WIRE)



D3001

Replaces internal GM coils with black, white and red wires.



GM HEI COIL "RACE ONLY"



D3070

"Race Only" coils when paired with race modules produce 42% more energy than our street/street version with 46% faster spark breakdown time allowing 48% more peak current to reach the spark plug between 6000 and 8500 RPM. Includes all necessary hardware.

GM REMOTE E-CORE COIL



D3002

Replaces remote GM coils found on 1985-95 Buick, Cadillac, Chevrolet, Oldsmobile and Pontiac vehicles.

FORD TFI E-CORE COIL



D3003

Flame-Thrower 50,000 volt TFI style coils breath new life into your 1982-96 Ford, Lincoln and Mercury ignition system. For maximum performance use our Flame-Thrower ignition TFI module found on page 55.



Part No.	Description	Finish	Turn Ratio	Primary Resistance	Secondary Resistance	Primary Inductance	Maximum Voltage	Matching Module
FLAME-THROWER 50,000 VOLT E-CORE COILS								
D3000	GM internal E-core coil with yellow wire	Black	80:1	0.5 Ohms	8.3k Ohms	4.4mH	50,000	D2000/D2001
D3001	GM internal E-core coil with white wire	Black	80:1	0.5 Ohms	8.3k Ohms	4.4mH	50,000	D2000/D2001
D3070	GM internal Racing E-core coil	Black	90:1	0.35 Ohms	8.0k Ohms	2.8mH	50,000	D2070
D3002	GM Remote E-core coil	Black	110:1	0.32 Ohms	6.8k Ohms	2.5mH	50,000	D2002
D3003	Ford TFI E-core coil	Black	90:1	0.32 Ohms	6.0k Ohms	2.8mH	50,000	D2010

FLAME THROWER LS COILS FOR GM ENGINES

Flame-Thrower Coils GM LS engines feature an optimized coil design for improved spark energy. Our coils are epoxy molded to prevent premature failure from moisture or winding fatigue. Direct OEM replacement form factor and connections means simple installation. Available individually or in sets of 8.



FEATURES

- Optimized coil design for improved spark energy
- Provides consistent spark energy throughout the RPM range and with no energy degradation up to 11,000 engine RPMs
- Moisture resistant construction ensures long life in harsh environments
- Plated terminals for added current conduction
- Epoxy molded for shock and vibration resistance
- Direct OEM replacement
- Legal in all 50 states and Canada (C.A.R.B. E.O. #D-57-21)
- Limited 90 Day Warranty

Part No.	Description	OEM Cross Reference	Turn Ratio	Primary Resistance	Secondary Resistance	Primary Inductance	Maximum Voltage
FLAME-THROWER COILS							
30821	GM LS1/LS6 (single coil)	AC-Delco # D580 / GM # 12558948	58:1	0.8 Ohms	7.5k Ohms	3.6mH	30,000
30828	GM LS1/LS6 (8 coils)	AC-Delco # D580 / GM # 12558948	58:1	0.8 Ohms	7.5k Ohms	3.6mH	30,000
30831	GM LS2/LS3/LS7 (single coil)	AC-Delco # D514A / GM # 12573190	83:1	0.72 Ohms	8.1k Ohms	2.06mH	32,000
30838	GM LS2/LS3/LS7 (8 coils)	AC-Delco # D514A / GM # 12573190	83:1	0.72 Ohms	8.1k Ohms	2.06mH	32,000
30841	GM LS Truck (single coil)	AC-Delco # D585 / GM # 10457730, 12563293	73:1	1.05 Ohms	11.6k Ohms	4.5mH	35,000
30848	GM LS Truck (8 coils)	AC-Delco # D585 / GM # 10457730, 12563293	73:1	1.05 Ohms	11.6k Ohms	4.5mH	35,000

Year	Model	Single	Set of 8
BUICK			
2009	Allure	30831	30838
2009	LaCrosse	30831	30838
2004-05	Rainier	30841	30848
2006-07	Rainier	30831	30838
CADILLAC			
2004-05	CTS	30821	30828
2006-07	CTS	30831	30838
2002-06	Escalade	30841	30848
2007-13	Escalade	30831	30838
2003-06	Escalade ESV	30841	30848
2007-13	Escalade ESV	30831	30838
2002-06	Escalade EXT	30841	30848
2007-13	Escalade EXT	30831	30838
2007-13	Avalanche	30831	30838
2002-06	Avalanche 1500	30841	30848
2002	Avalanche 2500	30821	30828
2003-06	Avalanche 2500	30841	30848
CHEVROLET			
2001-03	C3500	30821	30828
2001-02	C3500HD	30821	30828
1998-02	Camaro	30821	30828
2010-13	Camaro	30831	30838
2010-13	Cheyenne	30831	30838
2007-09	Cheyenne 2500	30831	30838
2009-12	Colorado	30831	30838
1997-04	Corvette	30821	30828
2005-13	Corvette	30831	30838
2003-07	Express 1500	30841	30848
2008-13	Express 1500	30831	30838
2003-07	Express 2500	30841	30848
2008-13	Express 2500	30831	30838
2001-02	Express 3500	30821	30828
2003-07	Express 3500	30841	30848
2008-13	Express 3500	30831	30838
2010-12	Express Pasajeros	30831	30838
2006-09	Impala	30831	30838
2006	Monte Carlo	30841	30848
2007	Monte Carlo	30831	30838
1999-06	Silverado 1500	30841	30848
2007-14	Silverado 1500	30831	30838
2001-07	Silverado 1500 HD	30841	30848
1999-06	Silverado 2500	30841	30848
2007-09	Silverado 2500	30831	30838
2001-02	Silverado 2500 HD	30821	30828
2001-07	Silverado 2500 HD	30841	30848
2008-13	Silverado 2500 HD	30831	30838
2001-02	Silverado 3500	30821	30828
2001-07	Silverado 3500	30841	30848
2007-09	Silverado 3500	30831	30838
2007	Silverado 3500 HD	30841	30848
2008-13	Silverado 3500 HD	30831	30838
2003-06	Sonora	30841	30848
2003-04	SSR	30841	30848
2005-06	SSR	30831	30838
2000-06	Suburban 1500	30841	30848
2007-13	Suburban 1500	30831	30838
2001-02	Suburban 2500	30821	30828
2000-06	Suburban 2500	30841	30848
2007-13	Suburban 2500	30831	30838
2000-06	Tahoe	30841	30848
2007-13	Tahoe	30831	30838
2006-09	Trailblazer	30831	30838
2003-04	Trailblazer EXT	30841	30848
2005-06	Trailblazer EXT	30831	30838

Year	Model	Single	Set of 8
GMC			
2001-02	C3500	30821	30828
2001-02	C3500HD	30821	30828
2009-12	Canyon	30831	30838
2005-09	Envoy	30831	30838
2003-04	Envoy XL	30841	30848
2005-06	Envoy XL	30831	30838
2004	Envoy XUV	30841	30848
2005	Envoy XUV	30831	30838
2003-07	Savana 1500	30841	30848
2008-13	Savana 1500	30831	30838
2003-07	Savana 2500	30841	30848
2008-13	Savana 2500	30831	30838
2001-02	Savana 3500	30821	30828
2003-07	Savana 3500	30841	30848
2008-13	Savana 3500	30831	30838
2007-13	Sierra	30831	30838
1999-07	Sierra 1500	30841	30848
2008-14	Sierra 1500	30831	30838
2001-07	Sierra 1500 HD	30841	30848
1999-04	Sierra 2500	30841	30848
2001-02	Sierra 2500 HD	30821	30828
2001-07	Sierra 2500 HD	30841	30848
2008-13	Sierra 2500 HD	30831	30838
2001-02	Sierra 3500	30821	30828
2001-07	Sierra 3500	30841	30848
2007	Sierra 3500 HD	30841	30848
2008-13	Sierra 3500 HD	30831	30838
2001	Sierra C3	30841	30848
2000-06	Yukon	30841	30848
2007-13	Yukon	30831	30838
2000-06	Yukon XL 1500	30841	30848
2007-13	Yukon XL 1500	30831	30838
2001-02	Yukon XL 2500	30821	30828
2000-06	Yukon XL 2500	30841	30848
2007-13	Yukon XL 2500	30831	30838
HUMMER			
2003-07	H2	30841	30848
2008-09	H2	30831	30838
2009-10	H3T	30831	30838
PONTIAC			
2098-02	Firebird	30821	30828
2008-09	G8	30831	30838
2005-08	Grand Prix	30831	30838
2004	GTO	30821	30828
2005-06	GTO	30831	30838

**CUSTOM AND UNIVERSAL WIRE SETS FOR LS ENGINES
CAN BE FOUND IN THE WIRES SECTION OF THIS CATALOG**



30,000 VOLT COIL ON PLUG FOR FORD ENGINES

Flame-Thrower Coils for 2, 3 and 4 valve Ford engines feature an optimized coil design which increases the spark energy by 15% over the OEM coils. Our coils are epoxy molded to prevent premature failure from moisture or winding fatigue. Direct OEM replacement form factor and connections for simple installation. Available individually or in sets of 8.

FEATURES

- Optimized coil design yields at least 15% more energy available for the spark than the most common OEM coils
- Provides the spark energy throughout the RPM range and with no energy degradation up to 11,000 engine RPMs
- Plated terminals for added current conduction
- High-temp silicone boot maintains perfect seal
- Epoxy molded for improved resistance to moisture, vibration and shock
- Ferrite suppressed secondary path reduces radiated electrical energy
- Direct OEM replacement with factory connector
- Limited 90 Day Warranty
- 50 State Legal CARB EO #D57-21

Year	Model		Single	Set of 8
UNIVERSAL				
All	4.6L/5.4L/6.8L modular engines	2 Valve Engine	30721	30728
All	4.6L/5.4L modular engines	3 Valve Engine	30731	30738
All	4.6L/5.4L modular engines	4 Valve Engine	30741	30748
FORD				
1998-09	Crown Victoria	2 Valve Engine	30721	30728
1997-03	E Super Duty	2 Valve Engine	30721	30728
1997-05	E-150	2 Valve Engine	30721	30728
1997-09	E-250, E-350	2 Valve Engine	30721	30728
2003-09	E-450	2 Valve Engine	30721	30728
2000-05	Excursion	2 Valve Engine	30721	30728
1997-04	Expedition	2 Valve Engine	30721	30728
2005-08	Expedition (Black boot)	3 Valve Engine	30731	30738
2002-06	Explorer	2 Valve Engine	30721	30728
2007-08	Explorer, Sport Trac (Black boot)	3 Valve Engine	30731	30738
2004-08	F-150 (Black boot)	3 Valve Engine	30731	30738
1997-09	F-150	2 Valve Engine	30721	30728
1997-99	F-250	2 Valve Engine	30721	30728
1999-04	F-250, F-350, F450	2 Valve Engine	30721	30728
2005-08	F-250, F-350, F-450, F550 (Black boot)	3 Valve Engine	30731	30738
1999-04	F53	2 Valve Engine	30721	30728
2006-08	F53 (Black boot)	3 Valve Engine	30731	30738
1999-04	F-550 Super Duty	2 Valve Engine	30721	30728
2005-06	GT	4 Valve Engine	30741	30748
1999-04	Mustang	2 Valve Engine	30721	30728
1999-04	Mustang Cobra	4 Valve Engine	30741	30748
2003-04	Mustang GT	4 Valve Engine	30741	30748
2005-08	Mustang (Black boot)	3 Valve Engine	30731	30738
2007-09	Mustang	4 Valve Engine	30741	30748
LINCOLN				
2002	Blackwood	2 Valve Engine	30721	30728
2005-08	Mark LT (Black boot)	3 Valve Engine	30731	30738
2005-08	Navigator (Black boot)	3 Valve Engine	30731	30738
1998-99	Navigator	2 Valve Engine	30721	30728
1998-09	Town Car	2 Valve Engine	30721	30728
MERCURY				
1998-09	Grand Marquis	2 Valve Engine	30721	30728
2003-04	Marauder	2 Valve Engine	30721	30728
2002-06	Moutaineer	2 Valve Engine	30721	30728
2007-08	Moutaineer (Black boot)	3 Valve Engine	30731	30738

2V ENGINE COIL ON PLUG



3V ENGINE COIL ON PLUG



4V ENGINE COIL ON PLUG



Digital HP

BIG POWER... SMALL PACKAGE

NEW



DIGITAL HP IGNITION BOX

The new **Digital HP** from PerTronix represents the latest innovation in Ignition technology. It's ultra-small form factor provides more installation options and the simple dial interface accommodates quick and easy adjustments. There is nothing small about the 187mJ of spark energy or exclusive features found only in the **Digital HP**. Available in black or silver anodized finish..

FEATURES

- Over 187 mJ of Spark Energy
30% more than competition
- Integrated 3 step digital REV limiter
Burnout limit, Launch control plus fatal over REV protection
- Multiple spark all the way to redline
Twice as fast as the competition for better spark timing and true multiple spark function
- RPM Activated trigger
Accurately control shift lights, solenoids and other RPM devices
- Ultra small form factor
70% smaller than competition for greater installation options
- Adjustable start retard
Easier starting for high compression and hard to start engines
- Locking Molex connector
Clean wire routing with positive wire harness retention
- Tachometer output lead
Pure digital tach signal plus added filters for OE tachometer compatibility
- Onboard diagnostics and tach calibration
- Available in a black or silver anodized finish
- 50 State Emissions Legal - CARB E.O. # D-57-37



BUNDLES AVAILABLE

SEE PAGE 45

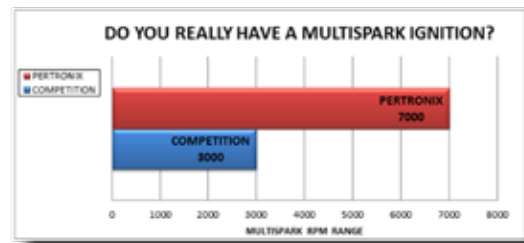

70% SMALLER



30% MORE ENERGY

SPECIFICATIONS

Operating Voltage: **9-22 Volts**
 Cranking Voltage: **8-22 Volts**
 Current Draw: **1.2A per 1,000 RPM**
 Input Triggers: **Points, Electronic, or Mag**
 Output Voltage: **530 Volts**
 Output Energy: **Up to 187 mJ primary**
 Tach Output Signal: **12v Square, 50% Duty**
 Multi-Spark Window: **Up to 20 crank degrees**
 Start Retard: **0-18 degrees / 500-1400 RPM**
 Weight: **0.7 Lbs.**
 Length: **4.18 Inches**
 Width: **5.75 Inches**
 Height: **1.65 Inches**
 Mounting Bolt Pattern: **3.5" x 3.25"**

Description	Part #
NEW Digital HP Ignition Box - Black anodized finish	510
NEW Digital HP Ignition Box - Silver anodized finish	512
Recommended Coils	Part #
NEW HP 50,000 Volt Epoxy Filled E-core design - Black	60100
Flame-Thrower III 45,000 Volt Oil Filled - Chrome	44001
Flame-Thrower III 45,000 Volt Oil Filled - Black	44011

THE ULTIMATE IGNITION SUPPLEMENT

Second Strike is the only ignition system to provide a powerful second spark throughout the entire RPM range. Other multiple spark discharge systems typically revert to one spark at about 3,000 RPM. The "Second Strike" is a microcontroller based ignition supplement that works with most inductive type systems (points, GM HEI, Chrysler electronic ignition, Ford TFI and Duraspark, Ignitor and Ignitor II). Following the primary spark the Second Strike delivers a powerful capacitive discharge second spark resulting in more complete combustion. At very high RPM's the increased burn time can reduce misfires, resulting in more peak horsepower and torque.

Second Strike's unique crank angle offset (CAO) feature gives you tunability that no other box has. Simply turn the dial and change the time, in crank angle degrees, that the second spark occurs. A wide range of adjustment gives you the flexibility to find which CAO works best for your engine.

The integrated digital rev limiter features easy to use rotary switches, that adjust the RPM limit to an ultra fine resolution of 100 RPMs, eliminating the need for old resistor style pills or chips. Proprietary algorithms provide superior control of rev limit and a rapid response time to over rev events, preventing engine failure.

Easy installation with a simple five wire hookup and detailed instructions. No special distributor or ignition coil are required.

FEATURES

- Only system to provide a second spark throughout the RPM range
- Powerful CD second spark resulting in more complete combustion
- Increased burn time increases horsepower and torque at high RPMs
- Unique (CAO) feature adjusts the timing of the second spark
- Built-in digital rev limiter with high resolution
- Digital rotary switches permit easy adjustment.
- Adaptive voltage feature prevents overdriving the ignition coil
- Voltage protection prevents damage from reversed polarity
- Tachometer output with TTL interface and near 50% duty cycle make our limiters compatible with most modern tachometers
- Legal in all 50 states and Canada (C.A.R.B. E.O. #D-57-22)
- Limited One Year Warranty

Description	Part No.
Second Strike	500

APPLICATION NOTES:

- For 4, 6 and 8 cylinder even fire engines with single coil inductive ignition system
- 12 Volt negative ground
- Not for use on computer controlled vehicles



TYPICAL MULTI-SPARK CD SYSTEM ABOVE 3,000 RPM

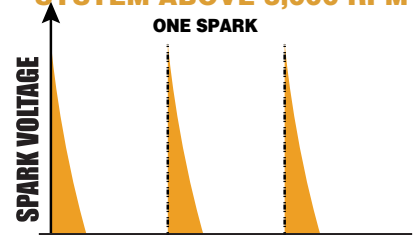

SECOND STRIKE ABOVE 3,000 RPM

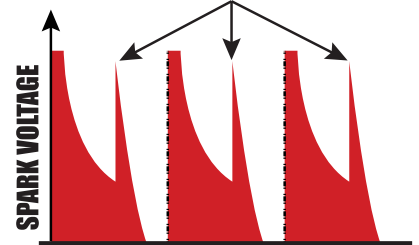

SPECIFICATIONS

Spark Energy:	245MJ
Primary Voltage:	200-700 Volts
Spark Timing:	Adjustable 2° -18°
Voltage Required:	11-18 VDC
Current Draw:	3.5 Amps @5,000 RPM
Size:	6"L X 4"W X 3"H
Weight:	2.3 Lbs.

FOOL PROOF CONTROL...

Flame-Thrower digital rev limiters work with most even fire 4, 6 or 8 cylinder engine using points, OEM electronic (GM HEI, Ford, Chrysler) or aftermarket inductive type ignition systems, including our very popular Ignitor and Ignitor II points replacement systems.

This digital microcontroller based unit provides a much greater accuracy (+/-0.01%) over analog systems. There is no need for old resistor style pills or chips, our easy to use rotary switches adjust the RPM limit to an ultra fine resolution of 100 RPMs. Our proprietary algorithms provides superior control of rev limits and a rapid response time to over rev limit events, preventing engine failure. Rev limiters come with multiple analog filters and one digital filter to prevent coil noise interference from affecting the established rev limit.

Installation is a snap with a four wire hookup and easy to understand instructions. The rev limiter's small size permits installation in even the most crowded engine compartment.



FEATURES

- Digital microcontroller based unit provides greater accuracy (+/-0.01%) over analog systems
- Easy to use rotary switches permit settings with a resolution of 100 RPMs
- Tachometer output with TTL interface and near 50% duty cycle make our limiters compatible with most modern tachometers
- Reverse voltage protection
- Conformal coated surface mount PCB for reliability
- Easy four wire hookup
- Compact size: 3"L X 2.5"W X 1.4"H
- Lightweight: 0.75 LBS
- Legal in all 50 states and Canada (C.A.R.B. E.O. #D-57-22)
- Limited One Year Warranty



Description	Part No.
Digital Rev Limiter	600

APPLICATION NOTES:

- For 4, 6 and 8 cylinder even fire engines with single coil inductive ignition system
- 12 Volt negative ground
- Not for use with (CD) Capacitive Discharge systems

8MM CUSTOM FIT MAGX2 SPARK PLUG WIRES

Most modern electronic ignition systems require suppression style wires to preserve sensitive components. Flame-Thrower 8mm Custom fit MAGx2 wires provide enhanced RFI suppression and dual current paths for more power delivered to the spark plug. Our custom wire sets have factory terminated ends for a superior connection and perfect fit, without cutting, crimping and splicing.



FEATURES

- Two current paths for reliability and redundancy
 - Primary path: Carbon impregnated fiberglass center core
 - Secondary path: Spiral wound stainless steel alloy
- Low 500 ohm per foot resistance
- 8mm Silicone jacket to resist high temperatures, moisture, oil and chemicals
- EPDM (Ethylene Propylene Diene Methylene) inner insulation for superior heat resistance and prevention of arcing and voltage leaks
- Fiberglass reinforcing braid for added strength and flexibility
- Lifetime Warranty

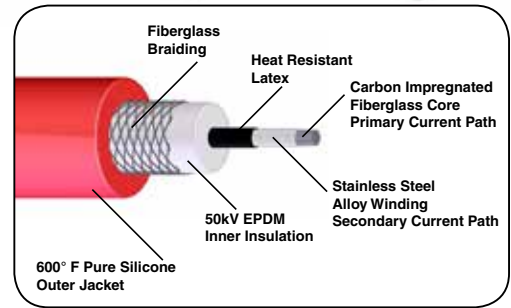

Year	Model	Cap/Coil Style	Cap/Coil Boot Angle	Plug Boot Angle	Black Part No.	Blue Part No.	Red Part No.
BUICK							
1974-75	Apollo 350 V8	Male Tower	90°	Straight	808201	808302	808403
1974-77	Century, Electra, LeSabre, Regal, Riviera 350 V8	Male Tower	90°	Straight	808201	808302	808403
1975	Apollo w/ Oldsmobile 260 V8	Male Tower	90°	Straight	808204	808305	808406
1975	LeSabre w/ Pontiac 400 V8	Male Tower	90°	Straight	808201	808302	808403
1975-76	Skylark 350 V8	Male Tower	90°	Straight	808201	808302	808403
1975-76	Skylark w/ Oldsmobile 260 V8	Male Tower	90°	Straight	808204	808305	808406
1975-77	Skylark w/ Oldsmobile 350 V8	Male Tower	90°	Straight	808204	808305	808406
1977	Century, Regal w/ Chevrolet 305-350 V8	Male Tower	90°	90°	808210	808311	808412
1977	Century, Regal w/ Oldsmobile 350-403 V8	Male Tower	90°	Straight	808204	808305	808406
1977-79	Electra, LeSabre w/ Oldsmobile 403 V8	Male Tower	90°	Straight	808204	808305	808406
1977-80	Electra, LeSabre, Riviera w/Oldsmobile 350 V8	Male Tower	90°	Straight	808204	808305	808406
1977-81	LeSabre w/ Pontiac 4.9L 301 V8	Male Tower	90°	90°	808201	808302	808403
1977-78	Riviera w/ Oldsmobile 403 V8	Male Tower	90°	Straight	808204	808305	808406
1977-79	Skylark w/ 305-350 Chevrolet V8	Male Tower	90°	90°	808210	808311	808412
1977	Skylark w/ Pontiac 301 V8	Male Tower	90°	Straight	808201	808302	808403
1978	Century Regal w/ Chevrolet 305-350 V8	Male Tower	Mixed	90°	808207	808308	808409
1978-80	Electra, LeSabre, Riviera 5.7L 350 V8	Male Tower	90°	Straight	808201	808302	808403
1978	LeSabre w/ Chevrolet 305-350 V8	Male Tower	90°	90°	808210	808311	808412
1979-81	Century, Regal w/ Pontiac 265, 301 V8	Male Tower	90°	Straight	808201	808302	808403
1980-85	Electra, LeSabre 5.7L 350 V8(Canada only)	Male Tower	90°	Straight	808201	808302	808403
1980-85	Riviera 5.0L 307 V8	Male Tower	90°	Straight	808204	808305	808406
1981-83	Electra 5.0L 307 V8	Male Tower	90°	Straight	808204	808305	808406
1981-90	Estate Wagon 5.0L 307 V8	Male Tower	90°	Straight	808204	808305	808406
1981-84	LeSabre 5.0L 307 V8	Male Tower	90°	Straight	808204	808305	808406
1986-87	Regal 5.0L 307 V8	Male Tower	90°	Straight	808204	808305	808406
1987	Regal 5.0L 305 V8(Canada only)	Male Tower	Mixed	90°	808207	808308	808409
1994-96	Roadmaster 5.7L LT1 V8	Female Socket	Mixed	90°	-----	-----	808421
2009	Lacrosse 5.3 V8	LS Coil	Straight	45°	-----	808330	808423
CADILLAC							
1976-80	Eldorado, Seville w/fuel inj 5.7L 350 V8	Male Tower	90°	Straight	808204	808305	808406
1986-90	Fleetwood Brougham 5.0L 307 V8	Male Tower	90°	Straight	808204	808305	808406
1994-96	Fleetwood Brougham 5.7L LT1 V8	Female Socket	Mixed	90°	-----	-----	808421
1999-00	Escalade 5.7L V8	Female Socket	Straight	90°	-----	-----	808424
2002-06	Escalade 5.3L, 6.0L V8	LS Coil	Straight	45°	-----	808330	808423
2009-12	Escalade, ESV, EXT 6.0L, 6.2L V8	LS Coil	Straight	45°	-----	808330	808423



Year	Model	Cap/Coil Style	Cap/Coil Boot Angle	Plug Boot Angle	Black Part No.	Blue Part No.	Red Part No.
CHEVROLET							
1974	Corvette 454Z V8	Male Tower	90°	Straight	808216	808317	808418
1974-75	Belair 350 V8	Male Tower	90°	90°	808210	808311	808412
1974-75	Belair, Chevelle, Malibu, Monte Carlo 454 V8	Male Tower	90°	Straight	808216	808317	808418
1974-76	Caprice, Chevelle, Impala 350 V8	Male Tower	90°	90°	808210	808311	808412
1974-76	Caprice, Impala 454 V8	Male Tower	90°	Straight	808216	808317	808418
1974-77	Malibu, Monte Carlo 305, 350 V8	Male Tower	90°	90°	808210	808311	808412
1974-79	Camaro, Caprice, Impala, Nova 350 V8	Male Tower	90°	90°	808210	808311	808412
1974-82	Corvette 5.7L 350 V8(under exhaust design)	Male Tower	90°	90°	808213	808314	808419
1975	Nova 262 V8	Male Tower	90°	90°	808210	808311	808412
1976-79	Camaro, Nova 305 V8	Male Tower	90°	90°	808210	808311	808412
1977-79	Caprice, Impala 305 V8	Male Tower	90°	90°	808210	808311	808412
1978	Malibu, Monte Carlo 305, 350 V8	Male Tower	Mixed	90°	808207	808308	808409
1980	Camaro 4.4L 267, 5.0L 305, 5.7L 350 V8(Excluding CA)	Male Tower	90°	90°	808210	808311	808412
1980-82	Caprice, Impala 5.7L 350 V8	Male Tower	Mixed	90°	808207	808308	808409
1981-82	Caprice, Impala, Malibu, Monte Carlo 4.4L 267 V8	Male Tower	Mixed	90°	808207	808308	808409
1981-86	Caprice, Impala, Monte Carlo 5.0L 305 V8	Male Tower	Mixed	90°	808207	808308	808409
1981-83	Malibu 5.0L 305 V8 (Uses two straight boots)	Male Tower	Mixed	90°	808207	808308	808409
1983-86	Camaro 5.0L 305 V8	Male Tower	Mixed	90°	808207	808308	808409
1983	Camaro 5.0L 305 V8 w/ cross-fire inj	Male Tower	Mixed	90°	808207	808308	808409
1983-86	Caprice, Impala 5.7L 350 V8	Male Tower	Mixed	90°	808207	808308	808409
1984-86	Camaro w/ H.O., 4BBL 5.0L 305 V8	Male Tower	Mixed	90°	808207	808308	808409
1984-86	Monte Carlo SS w/ H.O., 4BBL 5.0L 305 V8	Male Tower	Mixed	90°	808207	808308	808409
1986-87	Impala 5.0L 307 V8	Male Tower	90°	Straight	808204	808305	808406
1987-90	Caprice 5.0L 307 V8	Male Tower	90°	Straight	808204	808305	808406
1993-97	Camaro 5.7L LT1 V8	Female Socket	Mixed	90°	-----	-----	808421
1994-96	Caprice 4.3L, 5.7L LT1 V8	Female Socket	Mixed	90°	-----	-----	808421
1994-96	Impala SS 4.3L, 5.7L LT1 V8	Female Socket	Mixed	90°	-----	-----	808421
1997-02	Corvette 5.7L V8	LS Coil	Straight	45°	-----	808329	808422
1998-02	Camaro 5.7L V8	LS Coil	Straight	45°	-----	808329	808422
2000	Cavalier 5.7L V8	LS Coil	Straight	45°	-----	808329	808422
2009	Impala 5.3L V8	LS Coil	Straight	45°	-----	808330	808423
2009-12	Corvette 6.2L, 7.0L V8	LS Coil	Straight	45°	-----	808330	808423
2010-11	Camaro 6.2L V8	LS Coil	Straight	45°	-----	808330	808423
2011	Caprice 6.0L V8	LS Coil	Straight	45°	-----	808330	808423
CHEVROLET / GMC TRUCK							
1974-77	El Camino, Cabellero 305, 350 V8	Male Tower	90°	90°	808210	808311	808412
1975-79	PU, Motor Home Chassis, Van, Suburban 7.4L 454 V8	Male Tower	90°	Straight	808216	808317	808418
1975-80	Blazer, Jimmy, PU, Van, Suburban 305, 350, 400 V8	Male Tower	90°	90°	808210	808311	808412
1975-82	Motor Home, P Series Van 6.0L 366, 7.0L 427 V8	Male Tower	90°	Straight	808216	808317	808418
1978	El Camino, Cabellero 305, 350 V8	Male Tower	Mixed	90°	808207	808308	808409
1980-85	Motor Home Chassis, P Series Van 7.4L 454 V8	Male Tower	90°	Straight	808216	808317	808418
1980-85	Suburban, 2500HD, 3500 PU 7.4L 454 V8	Male Tower	90°	Straight	808216	808317	808418
1981	El Camino, Cabellero, w/ Pontiac 4.3L 265 V8	Male Tower	90°	Straight	808201	808302	808403
1981-82	El Camino, Cabellero 4.4L 267 V8	Male Tower	Mixed	90°	808207	808308	808409
1981-86	El Camino, Cabellero 5.0L 305 V8	Male Tower	Mixed	90°	808207	808308	808409
1981-86	G, P Series Vans, Motor Home Chassis 305-350 V8	Male Tower	90°	90°	808210	808311	808412
1981-86	Suburban 5.0L 305, 5.7L 350 V8	Male Tower	90°	90°	808210	808311	808412
1983-86	Blazer, Jimmy, PU, Suburban 5.0L 305, 5.7L 350 V8	Male Tower	Mixed	90°	808207	808308	808409
1987-88	G30, 35, P Series Van w/ 4BBL 5.7L 350 V8	Male Tower	90°	90°	808210	808311	808412
1987-88	Motor Home Chassis w/ 4BBL 5.7L 350 V8	Male Tower	90°	90°	808210	808311	808412
1987-88	Suburban w/ 4BBL 5.7L 350 V8	Male Tower	90°	90°	808210	808311	808412
1988-89	2500HD, 3500 PU w/ 4BBL 5.7L 350 V8	Male Tower	90°	90°	808210	808311	808412
1996-98	G10, G20, G30 Van, Van Express 5.0L, 5.7L V8	Female Socket	Straight	90°	-----	-----	808424
1996-99	C1500, K1500 Pickup 5.0L, 5.7L LT1 V8	Female Socket	Straight	90°	-----	-----	808424
1996-00	C2500, C3500 Pickup 5.0L, 5.7L V8	Female Socket	Straight	90°	-----	-----	808424
1996-00	K2500, K3500 Pickup, Suburban 5.0L, 5.7L V8	Female Socket	Straight	90°	-----	-----	808424
1996-99	P35/P3500 Van 5.7L V8	Female Socket	Straight	90°	-----	-----	808424
1996-99	Sierra Pickup 5.0L, 5.7L V8	Female Socket	Straight	90°	-----	-----	808424
1996-00	Suburban, Tahoe, Yukon 5.0L, 5.7L V8	Female Socket	Straight	90°	-----	-----	808424
1998	C1500 Pickup, Suburban 4.3L V6	Female Socket	Straight	Mixed	-----	-----	806426
1998	G1500, G2500 Van 4.3L V6	Female Socket	Straight	Mixed	-----	-----	806426
1998-04	S-10 Blazer, Pickup 4.3L V6	Female Socket	Straight	Mixed	-----	-----	806426
1998-05	Astro 4.3L V6	Female Socket	Straight	Mixed	-----	-----	806426
1999-02	Express 1500 4.3L V6	Female Socket	Straight	Mixed	-----	-----	806426
1999-02	Express 1500, 2500, 3500 5.0L, 5.7L V8	Female Socket	Straight	90°	-----	-----	808424

Year	Model	Cap/Coil Style	Cap/Coil Boot Angle	Plug Boot Angle	Black Part No.	Blue Part No.	Red Part No.
CHEVROLET / GMC TRUCK (CONTINUED)							
1999-02	Savana 1500, 2500, 3500 5.0L, 5.7L V8	Female Socket	Straight	90°	-----	-----	808424
1999-04	Express 2500 4.3L V6	Female Socket	Straight	Mixed	-----	-----	806426
1999-05	Silverado 1500 4.3L V6	Female Socket	Straight	Straight	-----	-----	806425
2000	C2500 Pickup, C3500 Pickup 4.3L V6	Female Socket	Straight	Mixed	-----	-----	806426
2000-01	Blazer Trail Blazer 4.3L V6	Female Socket	Straight	Mixed	-----	-----	806426
2005	Jimmy 4.3L V6	Female Socket	Straight	Mixed	-----	-----	806426
2005	Savana 2500 4.3L V6	Female Socket	Straight	Mixed	-----	-----	806426
2005-06	Safari 4.3L V6	Female Socket	Straight	Mixed	-----	-----	806426
2005-07	Savana 1500 4.3L V6	Female Socket	Straight	Mixed	-----	-----	806426
2008-12	Silverado 1500 4.3L V6	Female Socket	Straight	Mixed	-----	-----	806426
2009	Colorado V8 5.3L V8	LS Coil	Straight	45°	-----	808330	808423
2009	Envoy 5.3L V8	LS Coil	Straight	45°	-----	808330	808423
2009	Trail Blazer 6.0L V8	LS Coil	Straight	45°	-----	808330	808423
2009-10	Avalanche LS LT LTZ V8 5.3L, 6.0L V8	LS Coil	Straight	45°	-----	808330	808423
2009-10	Sierra Denali 6.2 L V8	LS Coil	Straight	45°	-----	808330	808423
2009-11	Savana 1500, 2500, 3500 4.8L, 5.3L, 6.0L V8	LS Coil	Straight	45°	-----	808330	808423
2009-11	Sierra 1500 4.8L, 5.3L, 6.0L, 6.2L V8	LS Coil	Straight	45°	-----	808330	808423
2009-11	Sierra 2500, 3500 HD 6.0L V8	LS Coil	Straight	45°	-----	808330	808423
2009-11	Yukon 4.8L, 5.3L, 6.0L, 6.2L V8	LS Coil	Straight	45°	-----	808330	808423
2009-11	Yukon XL 2500 6.0L V8	LS Coil	Straight	45°	-----	808330	808423
2009-12	Express 1500, 2500, 3500 4.8L 5.3L 6.0L V8	LS Coil	Straight	45°	-----	808330	808423
2009-12	Silverado 1500 4.8L, 5.3L, 6.0L 6.2L V8	LS Coil	Straight	45°	-----	808330	808423
2009-12	Silverado 2500, 3500 HD 6.0L 6.2L V8	LS Coil	Straight	45°	-----	808330	808423
2009-12	Suburban 2500 6.0L V8	LS Coil	Straight	45°	-----	808330	808423
2009-12	Tahoe 4.8L, 5.3L, 6.0L, 6.2L V8	LS Coil	Straight	45°	-----	808330	808423
2010-12	Suburban 1500 5.3L V8	LS Coil	Straight	45°	-----	808330	808423
2012	Colorado V8 5.3L V8	LS Coil	Straight	45°	-----	808330	808423
DODGE TRUCKS							
2000-03	Dakota V8 5.9L V8	Male Tower	Straight	90°	-----	808332	808428
2000-03	Durango V8 5.2L, 5.9L V8	Male Tower	Straight	90°	-----	808332	808428
2000-03	Ram 1500 Pickup 5.2L, 5.9L V8	Male Tower	Straight	90°	-----	808332	808428
2000-03	Ram 1500 Van 5.2L, 5.9L V8	Male Tower	Straight	90°	-----	808332	808428
2000-03	Ram 2500 Pickup 5.2L, 5.9L V8	Male Tower	Straight	90°	-----	808332	808428
2000-03	Ram 2500 Van 5.2L, 5.9L V8	Male Tower	Straight	90°	-----	808332	808428
2000-03	Ram 3500 Pickup 5.2L, 5.9L V8	Male Tower	Straight	90°	-----	808332	808428
2000-03	Ram 3500 Van 5.2L, 5.9L V8	Male Tower	Straight	90°	-----	808332	808428
FORD							
1958-60	All V8. exc. 292	Male Tower	90°	Straight	808220	808321	-----
1958-72	Thunderbird V8	Male Tower	90°	Straight	808220	808321	-----
1961-74	Full Size - Custom, Galaxie, LTD, Crown Victoria V8	Male Tower	90°	Straight	808220	808321	-----
1962-70	Fairlane V8	Male Tower	90°	Straight	808220	808321	-----
1963-70	Falcon V8	Male Tower	90°	Straight	808220	808321	-----
1964-73	F-Series V8	Male Tower	90°	Straight	808220	808321	-----
1965-73	Mustang V8	Male Tower	90°	Straight	808220	808321	-----
1966-72	Bronco V8	Male Tower	90°	Straight	808220	808321	-----
1968-76	LTD II, Torino, Ranchero V8	Male Tower	90°	Straight	808220	808321	-----
FORD TRUCKS							
1990	Bronco II 4.0L F/Inj.(X) V6	Female Socket	45°	90°	-----	-----	806324
1990-96	AeroStar 4.0L V6	Female Socket	45°	90°	-----	-----	806324
1990-96	Ranger 4.0L V6	Female Socket	45°	90°	-----	-----	806324
1991-96	Explorer 4.0L V6	Female Socket	45°	90°	-----	-----	806324
1997	AeroStar, AWD 4.0L V6	Female Socket	45°	90°	-----	-----	806325
1997-00	Explorer 4.0L V6	Female Socket	45°	90°	-----	-----	806325
1997-00	Ranger 4.0L V6	Female Socket	45°	90°	-----	-----	806325
2001-10	Explorer, Sport Trac 4.0L V6	Female Socket	Straight	90°	-----	806326	806420
2001-11	Ranger 4.0L V6	Female Socket	Straight	90°	-----	806326	806420
HUMMER							
2003-07	H2 6.0L V8	LS Coil	Straight	45°	-----	808330	808423
2008-09	H2 6.2L V8	LS Coil	Straight	45°	-----	808330	808423
2008-10	H3 5.3L V8 w/ Round Shaped Ignition Coils	LS Coil	Straight	45°	-----	808330	808423
LINCOLN							
1958-72	Continental V8	Male Tower	90°	Straight	808220	808321	-----

Year	Model	Cap/Coil Style	Cap/Coil Boot Angle	Plug Boot Angle	Black Part No.	Blue Part No.	Red Part No.
MERCURY							
1958-74	Full Size - Grand Marquis, Monterey V8 exc. 292 cid	Male Tower	90°	Straight	808220	808321	-----
1966-71	Comet, Meteor V8	Male Tower	90°	Straight	808220	808321	-----
1968-74	Cougar V8	Male Tower	90°	Straight	808220	808321	-----
1968-74	Montego V8	Male Tower	90°	Straight	808220	808321	-----
OLDSMOBILE							
1974-76	98, Cutlass, Delta 88, Toronado 350, 455 V8	Male Tower	90°	Straight	808204	808305	808406
1974-77	Omega 260, 350 V8	Male Tower	90°	Straight	808204	808305	808406
1975-82	Cutlass Supreme, Delta 88 4.3L 260 V8	Male Tower	90°	Straight	808204	808305	808406
1976-80	98, Cutlass, Delta 88 w/ Chevrolet 5.7L 350 V8	Male Tower	90°	Straight	808204	808305	808406
1977	Delta 88, Starfire w/ Chevrolet 305, 350 V8	Male Tower	90°	90°	808210	808311	808412
1977-78	Toronado 403 V8	Male Tower	90°	Straight	808204	808305	808406
1977-79	98, Cutlass, Delta 88 403 V8	Male Tower	90°	Straight	808204	808305	808406
1977-79	Omega w/ Chevrolet 305, 350 V8	Male Tower	90°	90°	808210	808311	808412
1978	Cutlass w/ Chevrolet 305, 350 V8	Male Tower	Mixed	90°	808207	808308	808409
1979	Delta 88 w/ Pontiac 301 V8	Male Tower	90°	Straight	808201	808302	808403
1979-80	Toronado w/ Chevrolet 5.7L 350 V8	Male Tower	90°	Straight	808204	808305	808406
1980-84	98, Delta 88 5.0L 307 V8	Male Tower	90°	Straight	808204	808305	808406
1980-85	Toronado 5.0L 307 V8	Male Tower	90°	Straight	808204	808305	808406
1981-88	Cutlass Supreme 5.0L 307 V8	Male Tower	90°	Straight	808204	808305	808406
1985-90	Custom Cruiser 5.0L 307 V8	Male Tower	90°	Straight	808204	808305	808406
PONTIAC							
1973-75	Grand Am, Grandville 350, 400, 455 V8	Male Tower	90°	Straight	808201	808302	808403
1973-76	Bonneville, Catalina, Grand Prix, LeMans 455, 350 V8	Male Tower	90°	Straight	808201	808302	808403
1973-77	Firebird, Grand Prix V8	Male Tower	90°	Straight	808201	808302	808403
1973-78	Bonneville, Catalina 400 V8	Male Tower	90°	Straight	808201	808302	808403
1973-79	Firebird 400 V8	Male Tower	90°	Straight	808201	808302	808403
1975-76	Ventura, Lemans w/ Oldsmobile 260 V8	Male Tower	90°	Straight	808204	808305	808406
1976-77	Bonneville, Catalina, Grand Prix 350 V8	Male Tower	90°	90°	808201	808302	808403
1977	Grand Prix, LeMans, Phoenix, Ventura w/Olds 350-403 V8	Male Tower	90°	Straight	808204	808305	808406
1977	Ventura 301 V8	Male Tower	90°	Straight	808201	808302	808403
1977	Ventura, w/ Chevrolet 305-350 V8	Male Tower	90°	90°	808210	808311	808412
1977-78	LeMans w/ Chevrolet 305 V8	Male Tower	Mixed	90°	808207	808308	808409
1977-79	Bonneville, Catalina, Firebird w/ Oldsmobile 403 V8	Male Tower	90°	Straight	808204	808305	808406
1977-79	Firebird 301 V8	Male Tower	90°	Straight	808201	808302	808403
1977-79	Firebird, Phoenix w/ Chevrolet 305, 350 V8	Male Tower	90°	90°	808210	808311	808412
1977-80	Bonneville, Catalina w/ Oldsmobile 5.7L 350 V8	Male Tower	90°	Straight	808204	808305	808406
1977-80	Bonneville, Catalina, Grand Prix, LeMans 4.9L 301 V8	Male Tower	90°	Straight	808201	808302	808403
1978	Grand Am, LeMans w/ Chevrolet 305, 350 V8	Male Tower	Mixed	90°	808207	808308	808409
1978	Grand Prix w/ Chevrolet 305, 350 V8	Male Tower	90°	90°	808210	808311	808412
1978-79	Firebird w/ Chevrolet 350 V8	Male Tower	90°	90°	808210	808311	808412
1978-80	Bonneville, Catalina, w/ Buick 5.7L 350 V8	Male Tower	90°	Straight	808201	808302	808403
1978-80	Grand Am 4.9L 301 V8	Male Tower	90°	Straight	808201	808302	808403
1980	Firebird 5.0L 305 V8	Male Tower	90°	90°	808210	808311	808412
1980-81	Bonneville, Catalina, Grand Prix, LeMans 4.4L 265 V8	Male Tower	90°	Straight	808201	808302	808403
1980-81	Firebird 4.9L 301 V8	Male Tower	90°	Straight	808201	808302	808403
1981	Bonneville, Catalina 5.0L 307 V8	Male Tower	90°	Straight	808204	808305	808406
1981	Catalina, LeMans 4.4L 267 V8	Male Tower	Mixed	90°	808207	808308	808409
1981	Firebird 4.4L 265 V8	Male Tower	90°	Straight	808201	808302	808403
1981-82	Bonneville, Grand Prix 4.4L 267 V8	Male Tower	Mixed	90°	808207	808308	808409
1982-86	Firebird 5.0L 305 V8	Male Tower	Mixed	90°	808207	808308	808409
1983	Firebird 5.0L 305 V8 w/ cross-fire inj	Male Tower	Mixed	90°	808207	808308	808409
1983-86	Bonneville, Grand Prix, Parisienne, Safari Wagon 5.0L V8	Male Tower	Mixed	90°	808207	808308	808409
1984-86	Firebird w/ 4BBL 5.0L 305 V8	Male Tower	Mixed	90°	808207	808308	808409
1986	Parisienne 5.0L 307 V8	Male Tower	90°	Straight	808204	808305	808406
1986-89	Safari Wagon 5.0L 307 V8	Male Tower	90°	Straight	808204	808305	808406
1993-97	Firebird LT1 V8	Female Socket	Mixed	90°	-----	-----	808421
1998-02	Firebird V8	LS Coil	Straight	45°	-----	808329	808422

8MM MAGX2 SPARK PLUG WIRES FOR SPECIALITY APPLICATIONS

Aftermarket distributors often require different spark plug wires. If you don't have the tools or time to make your own wire set, we have the solution. Our custom tailored sets match applications which use our line of Flame-Thrower performance distributors



Year	Cyl	Model	Dist. Cap Type	Plug Boot	Dist Boot	Black Part No.	Blue Part No.	Red Part No.	Yellow Part No.
AUSTIN									
1973-76	4	Marina All	Female Socket	90°	Straight	804206	804309	804412	-----
GM									
NEW All	8	LS All (Added header to boot clearance)	Female Socket	45°	45°	808224	808334	808429	-----
MG									
1967-80	4	MGB All	Female Socket	90°	Straight	804206	804309	804412	-----
1975-80	4	Midget 1500 cc	Female Socket	Straight	90°	804208	804311	804414	-----
TRIUMPH									
1952-67	4	TR2, TR3, TR4.	Female Socket	Straight	90°	804207	804310	804413	-----
1962-81	4	Spitfire	Female Socket	Straight	90°	804208	804311	804414	-----
1958-68	4	Herald 1200cc, 1300cc	Female Socket	Straight	90°	804208	804311	804414	-----
VOLKSWAGEN									
1961-79	4	All type I engines	Male Tower	Straight	90°	804202	804303	804404	804505

Marine wire sets for Chevrolet engines feature stainless steel terminals for superior corrosion resistance.

CHEVROLET MARINE ENGINES

All	8	SB & BB Marine engines	Female Socket	90°	90°	-----	-----	808450	-----
-----	---	------------------------	---------------	-----	-----	-------	-------	--------	-------

8MM MAGX2 UNIVERSAL SPARK PLUG WIRES

Universal 8mm spark plug wire kits allow you to build spark plug wires to match your unique engine and wire loom configuration. Universal kits are available with 90°, 45° or straight spark plug boot ends. Each kit includes terminals to fit both male tower and female socket style distributor caps. Check out our spark plug wire crimp tool and wire stripping tool on page 69.



Description	Plug Boot	Dist Boot	Black Part No.	Blue Part No.	Red Part No.
Universal 4 cylinder	Straight	90°	804280	804380	804480
Universal 4 cylinder VW style spark plug boots	Straight	90°	8042VW	8043VW	8044VW
Universal 8 cylinder	45°	90°	808215	808315	808415
Universal 8 cylinder	Straight	90°	808280	808380	808480
Universal 8 cylinder	90°	90°	808290	808390	808490
Universal LS 8 cylinder	Straight	45°	818280	818380	818480

8MM MAGX2 SPARK PLUG WIRE BY THE SPOOL

Now our 8mm wire featuring the "PerTronix Flame-Thrower MAGx2" Script is available by the spool. Each spool has 100 feet of wire, enough for four to five V8 engines.

Description	Part No.
100' Spool 8mm MAGx2 Spark Plug Wire Black	80S210
100' Spool 8mm MAGx2 Spark Plug Wire Blue	80S310
100' Spool 8mm MAGx2 Spark Plug Wire Red	80S410
100' Spool 8mm MAGx2 Spark Plug Wire Yellow	80S510



80S210

8MM UNIVERSAL MAGX2 CERAMIC BOOT SPARK PLUG WIRES

PerTronix MAGX2 Ceramic boot wires are the answer to your burnt wire blues. Each wire is constructed from two layers of ultra-high temperature silicone and rated up to 600°F. The Ceramic spark plug boot acts as the primary protection to direct heat withstanding up to 2,000°F. Available in universal sets with straight, 45 or 90-degree boot angle configurations. Kits include distributor boots and terminal for both male and female style distributor caps.

NEW



FEATURES

- Two current paths for reliability and redundancy
 - Primary path: Spiral wound stainless steel alloy
 - Secondary path: Carbon impregnated fiberglass center core
- Low 500 ohm per foot resistance
- 8mm ultra-high temperature silicone jacket and inner insulation rated at 600°F
- 2,000°F ceramic spark plug boots
- Lifetime Warranty

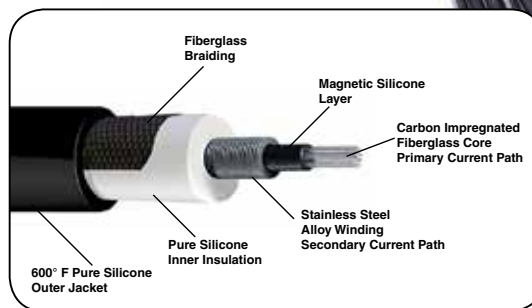

NEW
NEW
NEW

Description

Part No.

BLACK UNIVERSAL 8MM FLAME-THROWER SPARK PLUG WIRES

45° Degree Ceramic Boot	808215HT
Straight Ceramic Boot	808280HT
90° Degree Ceramic Boot	808290HT

NEW

BLACK SPECIFIC FIT 8MM FLAME-THROWER SPARK PLUG WIRES

45° Degree Ceramic Boot for LS engines	808224HT
----------------------------------------	----------

CERAMIC 8MM UNIVERSAL SPARK PLUG BOOTS

Universal ceramic spark plug wire boots provide the very best protection for application with tight fitting headers or exhaust manifolds. Our ceramic boots fit typical 8mm sparkplug wires and are available in straight, 45 or 90-degree boot angle configuration. Sold individually or in sets of 8 to retrofit an entire sparkplug wire set.



Description

Single Part No.

8 Pack Part No.

CERAMIC 8MM FLAME-THROWER SPARK PLUG BOOT

90° Degree Ceramic Spark Plug Boot	8501HT-1	8501HT-8
Straight Ceramic Boot	8502HT-1	8502HT-8
45° Degree Ceramic Boot	8503HT-1	8503HT-8

NEW
NEW
NEW

KIT INCLUDES

- Pure Silicone Plug and wire Bushings
- Spark Plug Terminals
- High Temp Ceramic Book

7MM "STOCK-LOOK" SPARK PLUG WIRES

Now you can get a "stock-look" spark plug wire, that performs! We've designed our 7mm wires with the same core we use in our 8mm wire. The only difference is the 7mm flat black silicone jacket that hides its performance potential from the naked eye. Get the best of both worlds with state-of-the-art performance and a "stock look." These wires will fit most original wire looms. Select a custom tailored set for a great out of the box fit or a universal kit to match your unique engine and wire loom configuration.



FEATURES

- Two current paths for reliability and redundancy
 - Primary path: Spiral wound stainless steel alloy
 - Secondary path: Carbon impregnated fiberglass center core
- Low 500 ohm per foot resistance
- 7mm Silicone jacket to resist high temperatures, moisture, oil and chemicals
- EPDM (Ethylene Propylene Diene Methylene) inner insulation for superior heat resistance and prevention of arcing and voltage leaks
- Fiberglass reinforcing braid for added strength and flexibility
- Lifetime Warranty

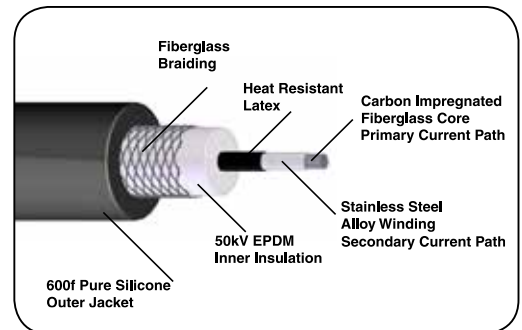

Year	Make / Model / Engine	Dist. Cap Type	Plug Boot	Dist Boot	Part No.
AMERICAN MOTORS					
1960-66	All 8 cylinder engines	Female Socket	Straight	90°	708104
1967-84	All 8 cylinder engines	Female Socket	Straight	Straight	708102
BUICK					
CENTURION, ELECTRA, LESABRE, RIVIERA, WILDCAT, PARK AVENUE					
1970-74	All 8 cylinder engines without HEI distributor	Female Socket	Straight	Straight	708102
1967-69	350, 400, 430, 455 engines	Female Socket	Straight	Straight	708102
1967	340 engines	Female Socket	Straight	90°	708105
1960-66	All 8 cylinder engines	Female Socket	Straight	90°	708105
APOLLO, CENTURY, REGAL, SKYHAWK, SKYLARK, SPECIAL, SUPER					
1968-74	All 6 cylinder engines	Female Socket	Straight	90°	706101
1968-74	All 8 cylinder engines	Female Socket	Straight	Straight	708102
1967	400 engines	Female Socket	Straight	Straight	708102
1953-67	All 8 cylinder engines (excluding 1967 400 engines)	Female Socket	90°	Straight	708103
CADILLAC					
1963-74	All 8 cylinder engines without HEI distributor	Female Socket	Straight	Straight	708102
1959-62	All 8 cylinder engines	Female Socket	90°	Straight	708103
1954-58	All 8 cylinder engines	Female Socket	Straight	Straight	708102
CHEVROLET					
BELAIR, BISCAYNE, CAPRICE, IMPALA					
1963-73	All 6 cylinder engines	Female Socket	Straight	90°	706101
1971-74	307, 350, 400 engines without HEI distributor	Female Socket	90°	Straight	708103
1965-74	396, 402, 427, 454 engines without HEI distributor	Female Socket	Straight	Straight	708102
1958-65	348, 409 engines	Female Socket	Straight	90°	708105
1955-70	283, 307, 327, 350, 400 engines (wires route under exhaust manifold)	Female Socket	90°	Straight	708101
CAMARO, Z-28, IROC-Z					
1967-74	All 6 cylinder engines	Female Socket	Straight	90°	706101
1967-74	283, 302, 307, 327, 350 engines without HEI distributor	Female Socket	90°	Straight	708103
1967-72	396, 402, 427, 454 engines	Female Socket	Straight	Straight	708102



Year	Make / Model / Engine	Dist. Cap Type	Plug Boot	Dist Boot	Part No.
CELEBRITY, CITATION, CHEVY II, NOVA					
1962-74	All 6 cylinder engines	Female Socket	Straight	90°	706101
1968-74	307, 327, 350 engines without HEI distributor	Female Socket	90°	Straight	708103
1968-70	396, 402 engines	Female Socket	Straight	Straight	708102
CHEVELLE, EL CAMINO, MONTE CARLO					
1964-74	All 6 cylinder engines	Female Socket	Straight	90°	706101
1964-74	283, 307, 327, 350, 400 engines without HEI distributor	Female Socket	90°	Straight	708103
1965-74	396, 402, 427, 454 engines	Female Socket	Straight	Straight	708102
CORVETTE					
1965-74	396, 427, 454 engines	Female Socket	Straight	Straight	708102
1955-74	265 - 350 engines without HEI distributor (under exhaust manifold)	Female Socket	90°	Straight	708101
CHEVROLET - GMC TRUCK					
1970-74	250, 292 engines	Female Socket	Straight	90°	706101
1966-69	G10, 20 Vans with 6 cylinder engines	Female Socket	Straight	90°	706101
1963-69	C, K 10, 20, 30 with 6 cylinder engines	Female Socket	Straight	90°	706101
1974	454 engines	Female Socket	Straight	Straight	708102
1974	P models with 400, 454 engines	Female Socket	90°	Straight	708103
1973-74	307, 350 engines	Female Socket	90°	Straight	708103
1972	1 Ton & Up with 366 engines	Female Socket	Straight	Straight	708102
1969-72	396, 402, 454 engines	Female Socket	Straight	Straight	708102
1955-72	283, 307, 327, 350 engines	Female Socket	90°	Straight	708101
CHRYSLER					
1979-89	5.2L 318, 5.9L 360 engines	Female Socket	Straight	90°	708105
1975-78	318, 340, 360 engines	Female Socket	Straight	90°	708105
1971-72	383, 400, 440 engines	Female Socket	90°	90°	708107
1971-72	Royal with 360 engines	Female Socket	Straight	90°	708105
1965-70	All 8 cylinder engines (excluding 1966 Imperial)	Female Socket	90°	90°	708107
1959-61	All 8 cylinder engines with Ram Induction (excluding Hemi engines)	Female Socket	90°	90°	708107
1955-58	All 8 cylinder engines (excluding Hemi engines)	Female Socket	Straight	90°	708105
DODGE					
1979-89	5.2L 318, 5.9L 360 engines.	Female Socket	Straight	90°	708105
1972-78	318, 340, 360 engines	Female Socket	Straight	90°	708105
1962-72	361, 383, 400, 440 engines	Female Socket	90°	90°	708107
1960-72	273, 318, 340, 360 engines	Female Socket	Straight	90°	708105
1960-62	383 engines with Ram Induction	Female Socket	90°	90°	708107
1956-57	All 8 cylinder engines (excluding Hemi engines)	Female Socket	Straight	90°	708105
DODGE TRUCK					
1974-89	5.2L 318, 5.6L 340, 5.9L 360 engines	Female Socket	Straight	90°	708105
1972-73	318, 360 engines with electronic ignition	Female Socket	Straight	90°	708105
1972-73	318, 360 engines with points ignition	Female Socket	90°	90°	708107
1961-71	318 engines	Female Socket	Straight	90°	708105
1961-71	383 engines	Female Socket	90°	90°	708107
FORD					
CUSTOM, GALAXIE, LTD, CROWN VICTORIA					
1954-64	All 6 cylinder engines	Female Socket	Straight	90°	706101
1973-76	All 8 cylinder engines	Female Socket	Straight	90°	708104
1970-72	302, 351W engines	Female Socket	Straight	90°	708105
1970-72	351C, 390, 400, 429 engines	Female Socket	Straight	90°	708104
1968-69	302, 351 engines	Female Socket	Straight	90°	708105
1967-69	390, 427, 428, 429 engines	Female Socket	Straight	90°	708104
1954-67	All 8 cylinder engines (excluding 292 engines)	Female Socket	Straight	90°	708105
FAIRLANE, TORINO, LTD II, RANCHERO					
1954-73	All 6 cylinder engines	Female Socket	Straight	90°	706101
1975-76	302, 351W, 351C, 400 engines	Female Socket	Straight	90°	708104
1972-74	All 8 cylinder engines	Female Socket	Straight	90°	708104
1967-71	289, 302, 351W engines	Female Socket	Straight	90°	708105
1967-71	351C, 390, 429 engines	Female Socket	Straight	90°	708104
1962-66	All 8 cylinder engines (excluding 292 engines)	Female Socket	Straight	90°	708105
FAIRMONT, MAVERICK					
1975-76	200, 250 engines	Female Socket	Straight	90°	706101
1970-74	All 6 cylinder engines	Female Socket	Straight	90°	706101
1975-76	302 engines	Female Socket	Straight	90°	708104
1971-74	302 engines	Female Socket	Straight	90°	708105

Year	Make / Model / Engine	Dist. Cap Type	Plug Boot	Dist Boot	Part No.
FORD (CONTINUED)					
FALCON					
1963-70	All 6 cylinder engines	Female Socket	Straight	90°	706101
1963-70	All 8 cylinder engines (excluding 292 engines)	Female Socket	Straight	90°	708105
GRANADA					
1975-76	200, 250 engines	Female Socket	Straight	90°	706101
1975-76	302, 351W engines	Female Socket	Straight	90°	708104
MUSTANG, MUSTANG II, PINTO					
1965-73	All 6 cylinder engines	Female Socket	Straight	90°	706101
1975-76	302 engines	Female Socket	Straight	90°	708104
1972-73	302, 351C engines	Female Socket	Straight	90°	708104
1967-71	351, 390, 428, 429 engines	Female Socket	Straight	90°	708104
1965-71	289, 302 engines	Female Socket	Straight	90°	708105
THUNDERBIRD					
1967-76	All 8 cylinder engines	Female Socket	Straight	90°	708104
1958-66	All 8 cylinder engines (excluding 292 engines)	Female Socket	Straight	90°	708105
FORD TRUCK					
1956-64	All 6 cylinder engines	Female Socket	Straight	90°	706101
1975-76	All 8 cylinder engines	Female Socket	Straight	90°	708104
1970-74	302 engines	Female Socket	Straight	90°	708105
1969-74	360, 390 engines	Female Socket	Straight	90°	708104
1969	302, 351 engines	Female Socket	Straight	90°	708105
1965-68	289, 302, 330, 352, 390 engines	Female Socket	Straight	90°	708105
1962	F-100, F-250 with 8 cylinder engines	Female Socket	Straight	90°	708104
INTERNATIONAL TRUCK					
1975-77	Scout, Traveller	Female Socket	Straight	90°	708104
1974	Scout, Travelall with 304 engine	Female Socket	Straight	90°	708104
JEEP					
1971-82	All 8 cylinder engines	Female Socket	Straight	Straight	708102
1968-71	J Series with 350 engines	Female Socket	Straight	Straight	708102
1966-68	J Series 327 engines	Female Socket	Straight	90°	708105
LINCOLN					
1975-76	460 engines	Female Socket	Straight	90°	708104
1961-74	All 8 cylinder engines	Female Socket	Straight	90°	708104
MERCURY					
MARAUDER, MARQUIS, MONTEREY					
1975-76	351C, 400, 460 engines	Female Socket	Straight	90°	708104
1965-74	All 8 cylinder engines	Female Socket	Straight	90°	708104
1961-64	All 8 cylinder engines	Female Socket	Straight	90°	708104
CAPRI, COMET, ZEPHR, BOBCAT					
1960-76	200, 250 engines	Female Socket	Straight	90°	706101
1975-76	302 engines	Female Socket	Straight	90°	708104
1971-74	All 8 cylinder engines	Female Socket	Straight	90°	708104
1963-70	221, 260, 289, 302 engines	Female Socket	Straight	90°	708105
COUGAR, XR-7					
1972-76	351C, 351W, 400, 460 engines	Female Socket	Straight	90°	708104
1967-71	289, 302 engines	Female Socket	Straight	90°	708105
1967-71	390, 400, 427, 428 engines	Female Socket	Straight	90°	708104
MONARCH					
1975-76	200, 250 engines	Female Socket	Straight	90°	706101
1975-76	302, 351W engines	Female Socket	Straight	90°	708104
MONTEGO					
1968-73	All 6 cylinder engines	Female Socket	Straight	90°	706101
1975-76	351, 400, 460 engines	Female Socket	Straight	90°	708104
1971-74	All 8 cylinder engines	Female Socket	Straight	90°	708104
1968-70	289, 302, 351 engines	Female Socket	Straight	90°	708105
1968-70	390, 400, 427, 428 engines	Female Socket	Straight	90°	708104

Year	Make / Model / Engine	Dist. Cap Type	Plug Boot	Dist Boot	Part No.
OLDSMOBILE					
88, 98, DELTA 88, TORONADO					
1971-74	350, 455 engines without HEI distributor	Female Socket	Straight	90°	708105
1949-70	All 8 cylinder engines	Female Socket	Straight	90°	708105
CALAIS, CIERA, OMEGA					
1973-74	250 engines	Female Socket	Straight	90°	706101
1973-74	350 engines	Female Socket	Straight	90°	708105
CUTLASS SUPREME, F85, 442					
1968-74	All 6 cylinder engines	Female Socket	Straight	90°	706101
1968-74	350, 400, 455 engines	Female Socket	Straight	90°	708105
1964-67	330, 400 engines	Female Socket	Straight	90°	708105
PLYMOUTH					
1960-61	383 engines with Ram Induction	Female Socket	90°	90°	708107
1960-89	273, 318, 340, 360 engines.	Female Socket	Straight	90°	708105
1964-68	361, 383, 413, 426 engines (excluding Hemi engines)	Female Socket	90°	90°	708107
1969-72	383, 400, 440 engines	Female Socket	90°	90°	708107
PONTIAC					
BONNEVILLE, CATALINA, GRAND PRIX					
1972-74	350, 400, 455 engines	Female Socket	Straight	Straight	708102
1960-71	All 8 cylinder engines	Female Socket	Straight	Straight	708102
FIREBIRD, TRANS AM, FORMULA, GTA					
1967-74	All 6 cylinder engines	Female Socket	Straight	90°	706101
1967-74	All 8 cylinder engines	Female Socket	Straight	Straight	708102
FIERO, GRAND AM, PHOENIX, SUNBIRD, VENTURA, J-2000, 6000, STE					
1971-74	All 6 cylinder engines	Female Socket	Straight	90°	706101
1971-74	All 8 cylinder engines without HEI distributor	Female Socket	Straight	Straight	708102
TEMPEST, LEMANS, GTO					
1964-74	All 6 cylinder engines	Female Socket	Straight	90°	706101
1964-74	All 8 cylinder engines without HEI distributor	Female Socket	Straight	Straight	708102
1962-63	All 8 cylinder engines	Female Socket	Straight	90°	708105
VOLKSWAGEN					
1961-79	All 4 cylinder type I engines No Script (Black)	Female Socket	Straight	Straight	704101
1961-79	All 4 cylinder type I engines With Flame-Thrower Script (Blue)	Female Socket	Straight	Straight	704301
1961-79	All 4 cylinder type I engines With Flame-Thrower Script (Red)	Female Socket	Straight	Straight	704401
1961-79	All 4 cylinder type I engines With Flame-Thrower Script (Yellow)	Female Socket	Straight	Straight	704501



708103



704101

7MM “STOCK-LOOK” UNIVERSAL SPARK PLUG WIRES

Universal 7mm spark plug wire kits have the same great features our pre-made kits have and are available with either 90° or straight spark plug boots. Each universal set includes terminals for both male and female terminal distributor caps. These kits come with extra long wires to accommodate most application. Check out our spark plug wire crimp tool and wire stripping tool on page 69.



Description	Plug Boot	Dist Boot	Part No.
Universal 4 cylinder	Straight	Straight	704180
Universal 4 cylinder	90°	Straight	704190
Universal 6 cylinder	Straight	Straight	706180
Universal 6 cylinder	90°	Straight	706190
Universal 8 cylinder	Straight	90°	708180
Universal 8 cylinder	90°	90°	708190

7MM “STOCK-LOOK” SPARK PLUG WIRE BY THE SPOOL

We’ve designed our 7mm wire with the same core we use in our 8mm wire. The only difference is the 7mm flat black silicone jacket which hides its performance potential from the naked eye. Get the best of both worlds with state-of-the-art performance and a “stock look.” Each spool has 100 feet of wire, enough for four to five V8 engines.



70S210

Description	Part No.
100' Spool 7mm “Stock-Look” Black Spark Plug Wire	70S210
100' Spool 7mm “Stock-Look” Yellow Spark Plug Wire	70S510

NEW



PERTRONIX QUICK CHANGE RATCHET CRIMP KITS

FEATURES

- Quick change dies. No Tools Required!
- Hardened Die sets are zinc plated Chrome-Moly for extra long life
- Ratchet crimp mechanism makes precision uniform crimps every time
- Rugged carbon steel tool body with corrosion resistant black oxide finish
- Ergonomic non slip over-molded rubber grip
- Ambidextrous Design
- Blow molded plastic case for tool storage

QUICK CHANGE RATCHET CRIMP KIT

Our 6 piece tool set enables quick, toolless die changes. Included are five dies for 5 common automotive solderless terminal types; Non Insulated terminals, Insulated terminals, D-Sub Terminals, Open Barrel terminals & Spark-Plug Terminals (One Tool for many uses). The adjustable ratcheting mechanism makes uniform precision crimps every time.

Description	Part No.
6 Piece Quick Change Ratchet Crimp Kit	T3001
Replacement Ratchet Tool Body Only	T3001-R

NEW

QUICK CHANGE RATCHET DIE SETS

Description	Part No.
Insulated A Die Set	T3001-A
Non-insulated B Die Set	T3001-B
Open Barrel C Die Set	T3001-C
Open D-Sub H Die Set	T3001-H
Spark Plug H1 Die Set	T3001-H1
Weatherpack H5 Die Set	T3001-H5

NEW
NEW
NEW
NEW
NEW



T3001



GM WEATHER PACK QUICK CHANGE RATCHET CRIMP KIT

The new PerTronix 220 piece weather pack crimp tool is a complete kit allowing for the assembly of Delphi weather pack connectors. Included are two quick interchangeable dies. This tool crimps and seals the terminal in one operation.

Description	Part No.
GM Weather Pack Tool & Connector Kit	T3005

NEW

SPARK PLUG WIRE STRIPPING TOOL

Now available PerTronix spark plug wire stripping tool. This easy to use tool drastically simplifies the process of making your own spark plug wire sets. Quickly and safely cut the spark plug wire jacket away from the conductor without damaging the core. Works with most 7mm and 8mm wire types.

Description	Part No.
Spark Plug Wire Stripping Tool	T3004

T3005



T3004





WARRANTY

- Ignitor®, Ignitor II, Ignitor III – 30 months.
- Industrial Distributor – 90 days mechanical / 30 months Ignitor
- Flame-Thrower®/Compu-Fire® Coils – 90 days
- Flame-Thrower® Spark Plug Wires – Lifetime
- Flame-Thrower® HEI Distributors and Component Parts – Limited 1 Year
- Flame-Thrower® Plug n' Play Billet and Cast Distributors – 1 Year Mechanical / 30 months module
- Second Strike® & Digital Rev Limiter – Limited 1 Year
- Digital HP Ignition Box – Limited 1 Year
- Contour Automotive Starters – Limited 1 Year
- Compu-Fire VW Ignition and Rotating Electrical – Limited 1 Year

LIMITED WARRANTY

PerTronix, Inc. warrants to the original Purchaser that its products shall be free from defects in material and workmanship for a period, as specified above, from the day of purchase. This warranty covers the replacement/repair of the product only and does not cover the cost of removal and installation.

Should a part become defective it should be returned to the original selling retailer and must be accompanied with the sales receipt.

If there is no retailer in your area, call the factory for a return authorization and return your part prepaid to the factory for inspection. The manufacturer reserves the right to replace or repair the alleged defective part and return the part freight collect.

PERTRONIX IGNITION PRODUCTS

**Your Complete Source For
Ignition Products!**



AUTOMOTIVE



AGRICULTURAL



INDUSTRIAL



MARINE

PerTronix Performance Brands

440 East Arrow Highway
San Dimas, CA 91773
Phone: (909) 599-5955
Fax: (909) 599-6424
www.pertronix.com

Part # **IGN2018**

